

॥ गुणवर्धनात् समृद्धिः ॥



Making in India
Since 1997

SHAVISON

Catalogue & Price List w.e.f. 1st April 2023 Issue-1

IS 13252(Part 1):2010
IEC 60950-1:2005



& CE on selected models

R-71016276
www.bis.gov.in

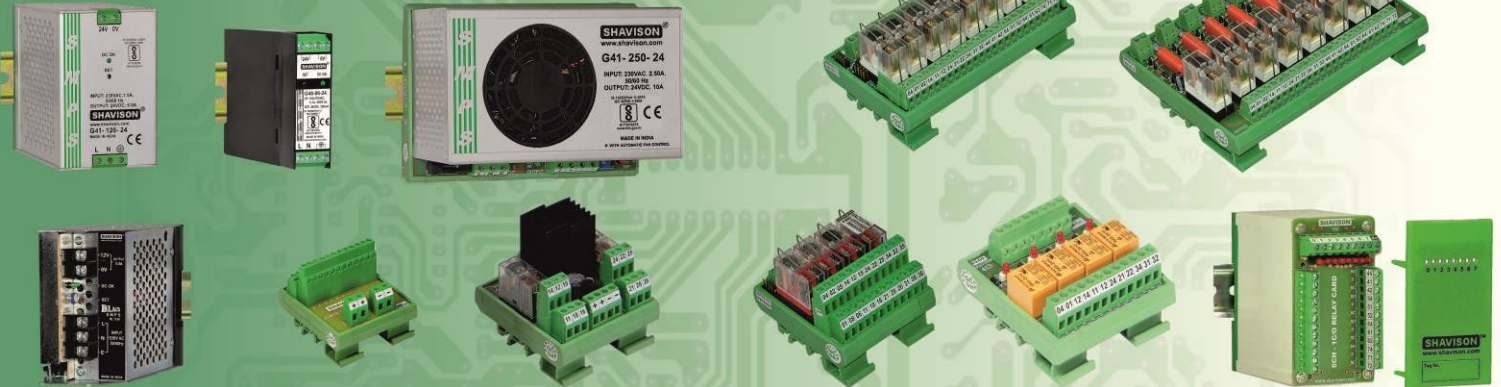

SMPS and Accessories

Relay Interface Modules



Signal Converters / Isolators

Protection Relays

Timers



Hooters

DC UPS

Battery Chargers



FRC / D-SUB (M/F)
Terminators & Cables

SSR / Opto Interface Modules

Peripherals for Industrial Automation

S M P S

Refer Page : [4,5,6,7](#)



on selected models

I/P Voltages	Universal (100-270VAC), 230VAC/DC, 110VAC/DC, 12VDC, 24VDC, 48VDC
O/P Voltages	5V, 12V, 15V, 24V, 48VDC
O/P Currents	250mA, 500mA, 1A, 1.5A, 2A, 2.5A, 4A, 5A, 8A, 10A, 15A, 20A DC

Power Distribution Modules

Refer Page : [8](#)

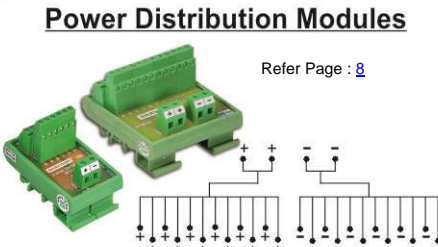

Input	100VDC / 230VAC	20A max
Output	1X6, 2 X 12 Way terminals rated for 5A each	

Redundancy Modules

Refer Page : [8](#)

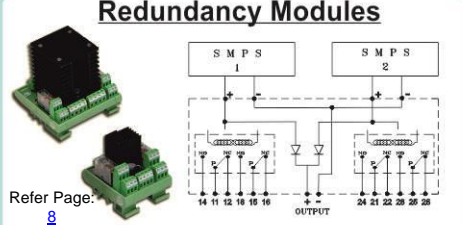

Voltage	Current	
	Redundant	Parallel
12VDC, 24VDC, 48VDC	10A	20A
	20A	40A

General Purpose SMPS

Refer Page : [5](#)



I/P Voltage	230VAC
O/P Voltage	12V : 5A, 24V : 2.5A, 24V : 5A

Battery Chargers

Refer Page : [9](#)



I/P Voltage	230VAC
O/P Voltages	12V, 24V, 36V, 48V, 60V
O/P Current	5A, 10A, 20A

Hooters

Refer Page : [25, 26](#)



Size	72x72mm, 96x96mm
Features	2 Tone, 8 Tone, LED Flasher with Accept Function on Front and/or Rear, Volume Control
Supply	Universal (12 to 240V DC or 20 to 240V AC), 230V AC, 24V DC

Relay Interface Modules

Refer Page : [10,11,12,13,14,15](#)



No. Of Channels	1, 2, 4, 6, 8, 12, 16
No. Of Contacts	1 N/O, 1 C/O, 2 C/O
Coil Voltage	AC: 24V, 48V, 110V, 230V DC: 5V, 12V, 24V, 48V, 110V
Coil Looping	Negative, Positive, Isolated

Space Saver Module

Refer Page : [12](#)



No. Of Channels	8
No. Of Contacts	1 C/O
Coil Voltage	DC 12V, 24V
Coil Looping	Negative, Positive
Dimensions	55 X 102 X 115 mm

SSR Modules

Refer Page : [15](#)



Input	Output	No. of Channels
3.3 - 30V, 5V, 12V, 24VDC, 15mA	24VDC, 2A, 2.5A	2, 4, 6, 8, 12, 16
	70-270VAC, 2A	
	12-48VDC, 1.5A	

Opto Interface Modules

Refer Page : [16](#)

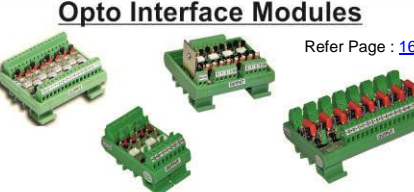

Input	Output	No. of Channels
1.3-1.8VDC, 5V, 12V, 24VDC, 110VAC, 230VAC, 15mA, Op. Freq upto 10 KHz	5V-30VDC(15mA)	2, 4, 6, 8, 12, 16
3-12V, 12V-30V, Aux Supply : 24VDC, Operating Freq upto 200 KHz	24VDC(10mA)	4

Analog Signal Converters

Refer Page : [18,19,20,21](#)



Input	0 - 20mV DC, 0 - 75mV DC, 0 - 200mV DC, 0 - 5VDC, 0 - 10V DC, 0 - 75V DC, 0 - 120V DC, 0 - 220V DC, 0 - 20mA, 4 - 20mA, 0 - 1Amp AC, 0 - 5Amp AC, K, J- Type, PT - 100, 1K - 10K POT and More...
Output	0-5VDC, 0-10VDC, 0-20mA, 4 - 20mA, 5 - 10KHz
No. of Outputs	Single, Dual
Aux. Supply	24VDC, 24VAC/DC, 90 - 270VAC/DC

DC UPS

Refer Page : [9](#)



I/P Voltages	110VAC, 230VAC
O/P Voltages	12V, 24V, 36V, 48V
O/P Currents	2A, 4A, 10A

Analog Timers

Refer Page : [23,24](#)



Operating Modes	ON Delay, ON Delay / Interval, Star-Delta, Cyclic ON First or OFF First, Pulse, Forward Pause Reverse, True Power OFF
Supply	Universal (12 to 240V DC or 20 to 240V AC), 230V AC, 110V AC, 24V AC/DC

Digital Timers

Refer Page : [22](#)



Size	48x48mm, 72x72mm, 96x96mm
Operating Modes	On Delay, Interval, Cyclic, Forward-Pause-Reverse, Batch Counting, Instantaneous + Delayed
Time Ranges	9.99, 99.9, 999 : Sec/Min/Hr 99.99, 999.9, 9999 : Sec/Min/Hr
Output Contact	DPDT(2 C/O), SPDT(1 C/O), SPST(1 NO)
Supply Voltage	85 - 270V AC/DC

Protection Relays

Refer Page : [22](#)



Protection Against	Auxiliary Supply Voltage
VPR: Phase Sequence, Phase Failure, Phase Imbalance, Under Voltage, Over Voltage	310 to 520V AC(L-L), 50 / 60Hz, 3Ø /3Wire
PSR: Phase Sequence, Phase Failure, Phase Imbalance, Under Voltage, Over Voltage	

FRC / D-SUB Terminators & Cables

Refer Page : [16](#)



FRC Connector pins	10, 14, 16, 20, 26, 34, 40, 50, 60, 64
D-SUB Connector pins male/female	9, 15, 25, 37, 50

Diode / Resistor Modules

Refer Page : [17](#)



Diodes	Common Anode / Common Cathode / Isolated
Resistors	With common terminal / Isolated
No. of Channels	1, 2, 4, 6, 8, 12, 16

Modbus I/O Modules

Refer Page : [26](#)

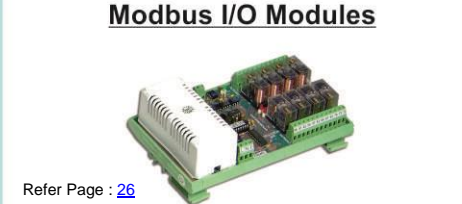

Interface	No. Of Input/Output	Aux. Supply
MODBUS - RTU Signals	8 D/I	90 - 270V AC
	8 Relay Contact Output	
	4 D/I + 4 Relay Contact Outputs	

Index (Category wise)

Product	Page No.
Low Power Slim SMPS 6W	4
SMPS – Enclosed DIN Rail Mount	
• 24W Single Output	4, 5, 6
• 60W Single Output	
• 120W Single Output	
• 250W Single Output	
General Purpose SMPS – DIN Rail + Screw Mounting	
• 60W	6
DC – DC Converters	
• 24W	6
• 120W	
• 70W Dual Output	
SMPS – Open Frame Type	
• 24W Single Output Open Frame	7, 8
• 25W Dual Output Open Frame	
• 60W Single Output Open Frame	
• 60W Multi Output Open Frame	
SMPS Accessories	
• Redundancy / Parallel Connection Module	8
• Power Distribution Module	8
DC UPS 120W	9
Battery Chargers	
• 120W	9
• 250W	
• 500W	
Voltage Monitor Relay / Dynamic Braking Resistor Protection	9
General Purpose Relay Interface Modules	
• 1 C/O General Purpose Relay Module	10
• 2 C/O General Purpose Relay Module	
• 1 C/O Fuse at pole General Purpose Relay Module	
Relay Interface Modules – Standard	
• 1 N/O Modules with Looped Coils	10
• 1 C/O Modules with Jumpers for Coil Looping & Reverse Blocking Diodes	10
• 1 C/O Modules with Looped Coils	11
• 1 C/O Modules with Looped / Isolated Coils (Sugar Cube Relay)	11
• 1 C/O Modules with High Voltage Isolated Coils	11
• 1 C/O Modules with 24VAC Isolated Coils	11
• 1 C/O Modules with Fuse at Poles, Looped coils	12
• 1 C/O Modules with High Voltage Isolated coils & Fuse at Poles	12
• 1 C/O 8 Channel Space Saver Relay Module	12
• 2 C/O Modules with Jumpers for Coil Looping & Reverse Blocking Diodes	12
• 2 C/O Modules with Looped Coils	13
• 2 C/O Modules with High Voltage Isolated Coils	13
Relay Interface Modules-Special	
• 1 N/O Relay Modules with Coil Connection Through FRC / HE10	13
• 1 C/O Relay Modules with 30A Contacts	13
• 1 C/O Relay Modules with High Voltage Isolated coils and 30A Contacts	13
• 1 C/O Relay Modules with 70A Contacts / Generator Control Interface	14
• 2 C/O High Sensitivity Signal Relay Modules with Jumpers for Coil looping	14
• 1 N/O with Coil Connection through FRC (ABB I/O Interface)	14
• CNC Specific Relay Module	14
• 2 C/O Relay Modules with FRC Connector Input & Cascading	
• 1 C/O Relay Modules with TTL / Low Current Input	14
• 1 C/O Low Signal Relay Modules with TTL / Low Current Input	
• 2 C/O Relay Modules with TTL / Low Current Input	14
• 2 C/O Relay Module with OPTO INPUT	15
Solid State Interface Modules	
➤ Isolated :	
• SSR DC-DC with Input : 3.3 ~ 30VDC, Output : 12V ~ 48VDC, 1.5A (Solenoid Driver)	15
• SSR DC-DC with Output : 24VDC, 2 A	15
• SSR DC-AC with Output : 70-270VAC, 2A	15
➤ Non – Isolated :	
• SSR DC-DC with Output : 24VDC, 2.5A (Solenoid Driver)	15
High Frequency Opto Interface Module	16
Opto Interface Modules	16
FRC / D-SUB (M/F) Terminators and Cables	16
Proximity Sensor Interface	17
Vibrator Control Card	17
Precision Reference Source 10VDC : 20mA	18
Diode / Resistor Modules	17
Analog Signal Converters / Isolators	
• Analog Signal Converters / Isolators - Dual Isolated Output (SC2 series)	18,
• Analog Signal Converters / Isolators - Dual Isolated Output	19, 20
• Analog Signal Converters / Isolators - Slim Size Single Output	20, 21
Digital Timers	22
Protection Relays	22
Analog Timers	
➤ 22.5mm DIN Rail / Base Mounted	
• ON Delay / Interval	23, 24
• True Power OFF	
• Cyclic ON First or OFF First	
• Forward-Pause-Reverse	
➤ 48 X 48mm Panel Mounted	
• ON Delay / Interval	24
• Cyclic ON First or OFF First	
Hooters	
• 72 X 72mm Standard	25
• 96 X 96mm Flasher with Base Mount	26
Hooter Accessories	
• Wall Mount Clamp	26
Modbus I/O Modules	26

Index (Order Code wise)

Order Code	Page No.
AS254	14
AS296	14
AS298	14
AS331	8
AS333	8
AS334	13
AS339	14
AS351	11
AS352	11
AS353	11
AS355	11
AS356	11
AS357	11
AS358	7
AS361	10
AS362	10
AS363	10
AS365	10
AS366	10
AS367	10
AS371	13
AS372	13
AS373	13
AS375	13
AS376	13
AS377	13
AS383	10
AS385	10
AS391	12
AS392	12
AS393	12
AS395	12
AS396	12
AS397	12
AS401	11
AS402	11
AS403	11
AS405	11
AS406	11
AS407	11
AS411	11
AS412	11
AS413	11
AS415	11
AS416	11
AS417	11
AS421	11
AS422	11
AS423	11
AS424	11
AS425	11
AS427	11
AS431	13
AS432	13
AS433	13
AS434	13
AS435	13
AS441	17
AS442	17
AS443	17
AS444	17
AS445	17
AS451	8
AS452	8
AS455	26
AS456	26
AS457	26









Order Code	Page No.
AS464	7
AS469	7
AS492	8
AS501	12
AS502	12
AS503	12
AS504	12
AS505	12
AS506	12
AS507	12
AS522	16
AS523	16
AS525	16
AS535	14
AS547	14
AS548	13
AS581	16
AS582	16
AS583	16
AS584	16
AS585	16
AS586	16
AS587	16
AS588	16
AS589	16
AS590	16
AS591	16
AS592	16
AS593	16
AS594	16
AS595	16
AS601	17
AS602	17
AS603	17
AS606	17
AS607	17
AS608	17
AS609	17
AS621	11
AS622	11
AS623	11
AS624	11
AS625	11
AS682	14
AS683	14
AS690	9
AS701	13
AS702	13
AS703	13
AS704	13
AS705	13
AS717	14
AS720	15
AS746-xxx	20, 21
AS772	15
AS773	15
AS775	15
AS780	17
AS782	15
AS783	15
AS785	15
AS789	12
AS793	15
AS795	15
AS802	12
AS803	12
AS805	12

Order Code	Page No.
AS845-xxx	19, 20
AS852	16
AS853	16
AS855	16
AS865-xxx	18
AS893	15
AS895	15
AS923	16
BCD-xxx	9
BCW-xxx	9
BL1250	4
BL2425	4
BL2450	4
DC UPS	9
FB468	26
G41-120-12	5
G41-120-15	5
G41-120-24	5
G41-120-48	5
G41-24-05	5
G41-24-10	17
G41-24-12	5
G41-24-15	5
G41-24-24	5
G41-24-48	5
G41-250-12	5
G41-250-15	5
G41-250-24	5
G41-250-30	5
G41-250-48	5
G41-360-12	5
G41-360-24	5
G41-360-36	5
G41-500-24	5
G41-500-48	5
G41-60-05	5
G41-60-12	5
G41-60-15	5
G41-60-24	5
G41-60-48	5
G31-70-12-05	6
G31-70-12-12	6
G31-70-15-15	6
G31-70-24-05	6
G31-70-24-12	6
G48-120-12	5
G48-120-15	5
G48-120-24	5
G48-120-48	5
G42-250-12	5
G42-250-15	5
G42-250-24	5
G42-250-30	5
G42-250-48	5
G48-60-05	5
G48-60-12	5
G48-60-15	5
G48-60-24	5
G48-60-48	5
G32-70-12-05	6
G32-70-12-12	6
G32-70-15-15	6
G32-70-24-05	6
G32-70-24-12	6
G34-24-05	6
G34-24-12	6
G34-24-24	6

Order Code	Page No.
G35-120-24	6
G35-70-15-15	6
G48-06-05	4
G48-06-12	4
G48-06-15	4
G48-06-24	4
GP04	10
GP08	10
GP16	10
GPF04	10
GPF08	10
H92G-230AC	25
H72S	25
H92F	25
H92F-230VAC-B	26
H92F-24VDC-B	26
H92S	25
H92S-24VDC-B	26
H98F-U	25
H98F-UB	26
PSR-415V	22
SC1	20
SC2	18
T4CY	24
T4DU	24
TACY-10H-U	23
TADU-*	23
TAFR-8M-U	24
TAON-*	23
TAPL-*	24
TASD-*	23
TATP-*	23
TD1D-48-24V	22
TD1D-48-Z	22
TD1D-72-24V	22
TD1D-72-Z	22
TD1D-96-24V	22
TD1D-96-Z	22
TD2D-48-24V	22
TD2D-48-Z	22
TD2D-72-24V	22
TD2D-72-Z	22
TD2D-96-24V	22
TD2D-96-Z	22
TDMF-48-24V	22
TDMF-48-Z	22
TDMF-72-24V	22
TDMF-72-Z	22
TDMF-96-24V	22
TDMF-96-Z	22
TDPW-48-24V	22
TDPW-48-Z	22
TDPW-72-24V	22
TDPW-72-Z	22
TDPW-96-24V	22
TDPW-96-Z	22
VPR-415V	22
WA-FRC-xxx	16
WA-DSUB-xxx	16

Note : Order codes listed above are make to order items. Kindly contact factory.





SMPS : Comparison



Feature		Competitors
Compact	<p>✓ DIN Rail : 35mm</p> 	<p>✗ NA</p> 
Mounting	<p>✓</p>  <p>⌚ < 10 secs, Plug & play</p>	<p>✗ NA</p>  <p>⌚ 25 minutes & base plate required</p>
International Approvals/Marks	<p>✓ CE mark for 60W & 120W and Din Rail mounting with low cost</p>	<p>✗ NA</p>
Made In	<p>✓ India </p>	<p>✗ China </p>
Specifications present on front plate	<p>✓ Power OK indication, terminations, output set control & rating details on front</p>	<p>✗ NA</p>
Separate Input & Output terminations	<p>✓ </p>	<p>✗ </p>
Price	<p>✓ Competitive Pricing</p>	<p>✗ Marginally Cheaper</p>



Price List

wef 1st Apr 2023





SMPS HSN : 85044090	Input	Output (DC)		Order Code	MRP (₹ each)	Availability (UR : Upon Request)	
		Voltage	Current				
 <p>6W</p> <p>http://www.shavison.com/pdf/23100.pdf</p>	Universal Input : 100 to 270VAC 110 to 360VDC	3.3V	1.8A	G48-06-03	UR	UR	
		4.2V	1.4A	G48-06-04			
		5V	1.2A	G48-06-05	740	UR	UR
		6V	1A	G48-06-06			
		10V	600mA	G48-06-10	700	Ex Stock	
		12V	500mA	G48-06-12			
		15V	400mA	G48-06-15	730	UR	
		24V	250mA	G48-06-24	640	Ex Stock	
 <p>24W</p> <p>http://www.shavison.com/pdf/23200.pdf</p>	Nominal : 230VAC/DC Range : 185 to 270VAC 200 to 360VDC	12V	2A	G41-24-12	1200	Ex Stock	
		24V	1A	G41-24-24	1030	Ex Stock	
	Universal Input : 100 to 270VAC 110 to 360VDC	5V	4A	G48-24-05	1290	UR	
		10V	2.4A	G48-24-10	UR		
		12V	2A	G48-24-12	1250		
		15V	1.5A	G48-24-15	1410		
		24V	1A	G48-24-24	1080		
		28V	0.8A	G48-24-28	UR		
		36V	0.6A	G48-24-36			
		48V	0.5A	G48-24-48	1440		
 <p>60W</p> <p>http://www.shavison.com/pdf/23300.pdf</p>	Nominal : 230VAC/DC Range : 185 to 270VAC 200 to 360VDC	5V	8A	G41-60-05	UR	UR	
		12V	5A	G41-60-12	1730	Ex Stock	
		15V	4A	G41-60-15	UR	UR	
		19V	3.1A	G41-60-19	UR		
		24V	2.5A	G41-60-24	1490	Ex Stock	
		28V	2.1A	G41-60-28	UR	UR	
		36V	1.6A	G41-60-36			
		48V	1.25A	G41-60-48	1940		
	Universal Input : 100 to 270VAC 110 to 360VDC	5V	8A	G48-60-05	1950	UR	
		12V	5A	G48-60-12	1820		
		15V	4A	G48-60-15	2020		
		19V	3.1A	G48-60-19	UR		
		24V	2.5A	G48-60-24	1580		Ex Stock
		28V	2.1A	G48-60-28	UR		UR
36V	1.6A	G48-60-36					
48V	1.25A	G48-60-48	2060				
 <p>120W</p> <p>http://www.shavison.com/pdf/23400.pdf</p>	Nominal : 230VAC/DC Range : 185 to 270VAC 200 to 360VDC	5V	15A	G41-120-05	UR	UR	
		12V	8A	G41-120-12	2140	Ex Stock	
		15V	8A	G41-120-15	2190	Ex Stock	
		19V	6.3A	G41-120-19	UR	UR	
		24V	5A	G41-120-24	1790	Ex Stock	
		28V	4.2A	G41-120-28	UR	UR	
		36V	3.3A	G41-120-36	2220	UR	
		48V	2.5A	G41-120-48	2250		
	Universal Input : 100 to 270VAC 110 to 360VDC	5V	15A	G48-120-05	UR	UR	
		12V	8A	G48-120-12	2240		
		15V	8A	G48-120-15	2290		
		19V	6.3A	G48-120-19	UR		
		24V	5A	G48-120-24	1890		Ex Stock
		28V	4.2A	G48-120-28	UR		UR
36V	3.3A	G48-120-36	2320				
48V	2.5A	G48-120-48	2370				

SMPS HSN : 85044090	Input	Output (DC)		Order Code	MRP (₹ each)	Availability (UR : Upon Request)
		Voltage	Current			
 IS 13252(Part 1):2010 IEC 60950-1:2005 R-71018276 www.bis.gov.in 250W http://www.shavison.com/pdf/23500.pdf	Nominal : 230VAC/DC Range : 185 to 270VAC 220 to 360VDC	12V	20A	G41-250-12	4470	Ex Stock
		15V	15A	G41-250-15	4540	UR
		19V	12.6A	G41-250-19	UR	UR
		24V	10A	G41-250-24	3570	Ex Stock
		30V	8A	G41-250-30	4590	UR
		36V	6.5A	G41-250-36	UR	
		48V	5A	G41-250-48	4440	
	Nominal : 110VAC/DC Range : 90 to 130VAC 100 to 160VDC	12V	20A	G42-250-12	UR	UR
		15V	15A	G42-250-15	UR	
		19V	12.6A	G42-250-19	UR	
		24V	10A	G42-250-24	3840	
		30V	8A	G42-250-30	UR	
		36V	6.5A	G42-250-36	UR	
		48V	5A	G42-250-48	4790	
 IS 13252(Part 1):2010 IEC 60950-1:2005 R-71018276 www.bis.gov.in (In Process) 360W http://www.shavison.com/pdf/23600.pdf	Nominal : 230VAC/DC Range : 185 to 270VAC 220 to 360VDC	12V	30A	G41-360-12	5600	UR
		24V	15A	G41-360-24	4540	
		36V	10A	G41-360-36	4880	
		48V	5A	G41-360-48	UR	
 IS 13252(Part 1):2010 IEC 60950-1:2005 R-71018276 www.bis.gov.in (In Process) 500W http://www.shavison.com/pdf/23700.pdf	Nominal : 230VAC/DC Range : 185 to 270VAC 220 to 360VDC	15V	25A	G41-500-15	UR	UR
		24V	20A	G41-500-24	6340	
		36V	13A	G41-500-36	UR	
		48V	10A	G41-500-48	7490	



General Purpose SMPS DIN Rail + Screw Mounting HSN : 85044090	Input	Output		Order Code	MRP (₹ each)	Availability (UR : Upon Request)
		Voltage DC	Current at Nominal Input			
 IS 13252(Part 1):2010 IEC 60950-1:2005 R-71018276 www.bis.gov.in 60W http://www.shavison.com/pdf/21250.pdf	Nominal : 230VAC/DC Range : 185 to 270VAC 200 to 360VDC	12V	5.0A	BL1250	1330	Ex Stock
		24V	2.5A	BL2425	1230	Ex Stock
 IS 13252(Part 1):2010 IEC 60950-1:2005 R-71018276 www.bis.gov.in 120W http://www.shavison.com/pdf/21350.pdf	Nominal : 230VAC/DC Range : 185 to 270VAC 200 to 360VDC	24V	5.0A	BL2450	1440	Ex Stock
		48V	2.5A	BL4825	1860	3 weeks

SMPS HSN : 85044090	Input	Output		Order Code	MRP (₹ each)	Availability (UR : Upon Request)
		Voltage DC	Current at Nominal Input			
 <p>IS 13252 Part 11:2019 IEC 60950-1:2005</p> <p>70W Dual Output</p> <p>http://www.shavison.com/pdf/22000.pdf</p>	Nominal : 230VAC/DC *With de-rating: 100 to 270VAC 110 to 360VDC	+5V	5A	G31-70-05-05	2520	UR
		-5V	1.5A			
		+12V	4A	G31-70-12-12		
		-12V	1.5A			
		+15V	3A	G31-70-15-15		Ex Stock
		-15V	1.5A			
		+24V	2A	G31-70-24-05		Ex Stock
		+5V	1.5A			
		+24V	2A	G31-70-24-12		Ex Stock
		+12V	1.5A			
	Nominal : 110VAC/DC Range : 90 to 130VAC 100 to 160VDC	+12V	4A	G31-70-12-05	UR	
		+5V	1.5A			
		+5V	5A	G32-70-05-05		
		-5V	1.5A			
		+12V	4A	G32-70-12-12		
		-12V	1.5A			
		+15V	3A	G32-70-15-15		
		-15V	1.5A			
		+24V	2A	G32-70-24-05		
		+5V	1.5A			
+24V	2A	G32-70-24-12				
+12V	1.5A					
+12V	4A	G32-70-12-05				
+5V	1.5A					

* : For de-rating refer datasheet

DC – DC Converter HSN : 85044090	Input	Output	Order Code	MRP (₹ each)	Availability (UR : Upon Request)
 <p>24W</p> <p>http://www.shavison.com/pdf/21110.pdf</p>	Nominal : 24VDC Input Range : 18 to 36VDC	5VDC : 2.5A	G34-24-05	1510	3 Weeks
		12VDC : 2A	G34-24-12	1530	
		24VDC : 1A	G34-24-24	1480	
• Contact us for other Input / Output requirements.					
 <p>120W</p> <p>G34 : http://www.shavison.com/pdf/21320.pdf G35 : http://www.shavison.com/pdf/21310.pdf</p>	Nominal : 24VDC Input Range : 18 to 36VDC	24VDC : 4A	G34-120-24	2690	3 Weeks
	Nominal : - 48VDC Input Range : -38 to -60VDC	24VDC : 5A	G35-120-24	2640	3 Weeks
• Contact us for other Input / Output requirements.					
 <p>70W Dual Output</p> <p>http://www.shavison.com/pdf/22100.pdf</p>	Nominal : 48VDC Input Range : 38 to 60VDC	+15V : 3A	G35-70-15-15	UR	3 Weeks
		-15V : 1.5A			
• Contact us for other Input / Output requirements.					

Open Frame SMPS HSN : 85044090	Input	Output		Order Code	MRP (₹ each)	Availability (UR : Upon Request)				
		Voltage DC	Current at Nominal Input							
<p>24W Single O/P http://www.shavison.com/pdf/31100.pdf</p>	Universal Input : 100 to 270VAC 110 to 360VDC	5V	4A	AS358-151	900	1-2 weeks				
		12V	2A	AS358-153						
		15V	1.5A	AS358-154						
		24V	1A	AS358-155						
		48V	0.5A	AS358-156						
<ul style="list-style-type: none"> • Add suffix D to order code for DIN Rail Mounting base. * : For de-rating refer datasheet 										
<p>60W Single O/P http://www.shavison.com/pdf/31200.pdf</p>	Nominal : 230VAC/DC Range : 185 to 270VAC 200 to 360VDC	12V	5A	AS464-102	1140	2 weeks				
		15V	4A	AS464-103						
		24V	2.5A	AS464-104						
		36V	1.6A	AS464-105						
		28V	2A	AS464-106						
	Nominal : 110VAC/DC Range : 90 to 130VAC 100 to 160VDC	12V	5A	AS464-152	UR					
		15V	4A	AS464-153						
		24V	2.5A	AS464-154						
		36V	1.6A	AS464-155						
		28V	2A	AS464-156						
Dual Output Open Frame SMPS HSN : 85044090	Input	Output		Order Code	MRP (₹ each)	Availability (UR : Upon Request)				
<p>25W Dual O/P http://www.shavison.com/pdf/32100.pdf</p>	Nominal : 230VAC/DC Range : 185 to 270VAC 200 to 360VDC	5V : 2.5A	12V : 2A*	AS469-101	1000	UR				
		5V : 2.5A	24V : 1A*	AS469-102						
		+15V : 1.5A	-15V : 1.5A*	AS469-103						
		12V : 1.5A	12V : 1.5A*	AS469-104						
		8V : 250mA	17V : 1.5A*	AS469-106						
		+12V : 1.5A	-12V : 200mA	AS469-114						
		5V : 2.5A	-5V : 100mA	AS469-115						
	Nominal : 110VAC/DC Range : 90 to 130VAC 100 to 160VDC	5V : 2.5A	12V : 2A*	AS469-151	UR					
		5V : 2.5A	24V : 1A*	AS469-152						
		+15V : 1.5A	-15V : 1.5A*	AS469-153						
		12V : 1.5A	12V : 1.5A*	AS469-154						
		8V : 250mA	17V : 1.5A*	AS469-156						
		<ul style="list-style-type: none"> • * : Unreg. Output • Add suffix C to order code for CPU connector at I/O Terminals. • Add suffix D to order code for DIN Rail Mounting plastic base. 								
		Contact us for specific requirements								



Open Frame SMPS HSN : 85044090	Input	Output	Order Code	MRP (₹ each)	Availability (UR : Upon Request)
 CPU Type I/O Connector  Screw Type I/O Terminals 60W* Multiple O/P http://www.shavison.com/pdf/33100.pdf	Nominal : 230VAC/DC Range : 185 to 270VAC 200 to 360VDC	5V : 1A +/- 5V : 100mA +/- 12V : 250mA 34V : 1.5A	AS492-101C	UR	3 weeks
		12V : 750mA +/- 5V : 350mA 24V : 50mA	AS492-102C		
		12V : 350mA 15V : 2A OR 30V : 2A	AS492-103C		
		12V : 350mA 15V : 2A OR 30V : 2A 5V : 350mA	AS492-104C		
		5V : 1A 24V : 2.5A 5V : 500mA	AS492-105C		
		5V : 1A +/- 5V : 100mA +/- 12V : 250mA 24V : 1.5A	AS492-106C		
		5V : 2A 12V : 1.5A 24V : 600mA	AS492-107C		
	100 - 270VAC	5V:2A -5V:0.3A 12V:0.3A 24V:1.5A	AS492-108C		
	100 - 270VAC	5V : 2A - 5V : 300mA 12V : 300mA 48V : 1.5A	AS492-109C		
	230VAC/DC Range : 185 to 270VAC 200 to 360VDC	5V : 1A +/- 5V : 100mA +/- 12V : 250mA 13V : 1.5A	AS492-111C		
• Remove suffix C from order code for screw Type I/O Terminals (C – CPU connector) *Total wattage should not exceed 60W (For details refer datasheet)					

Contact us for specific requirements





SMPS - Accessories HSN : 85437099	Description	Current Rating		Input	Order Code	MRP (₹ each)	Availability (UR : Upon Request)
		Redundant	Parallel				
 Redundancy / Paralleling Modules http://www.shavison.com/pdf/42000.pdf Application Note	• 2C/O Monitor relay across each power supply	20A	40A	12VDC	AS451-101	1690	2 Weeks
				24VDC	AS451-102		Ex Stock
				48VDC	AS451-103		2 Weeks
				15VDC	AS451-104		2 Weeks
		10A	20A	12VDC	AS452-101	790	2 Weeks
				24VDC	AS452-102		Ex Stock
				48VDC	AS452-103		2 Weeks
				110VDC	AS452-105		1600



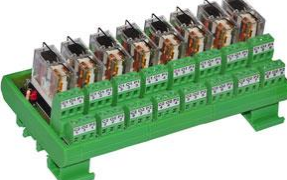

HSN : 85369090	Description	Order Code	MRP (₹ each)	Availability (UR : Upon Request)
• Voltage Rating : 100VDC / 230VAC • Current Rating Input : 20A max. • Current Rating Output : 5A per channel • Input side : 2 x 2 way Terminals • Output side : 12 x 2 way Terminals	AS333	290	Ex Stock	





DC UPS HSN : 85044090	Input	Output		Order Code	MRP (₹ each)	Availability (UR : Upon Request)
		Voltage DC	Current at Nominal Input			
 120W http://www.shavison.com/pdf/F1000.pdf	Nominal : 230VAC	12V	10A	DCUPS-1-120-12	3020	3 Weeks
		24V	4A	DCUPS-1-120-24	2890	3 Weeks
		36V	2.6A	DCUPS-1-120-36	UR	UR
		48V	2A	DCUPS-1-120-48	UR	UR
	Nominal : 110VAC	12V	10A	DCUPS-2-120-12	UR	UR
		24V	4A	DCUPS-2-120-24	UR	UR

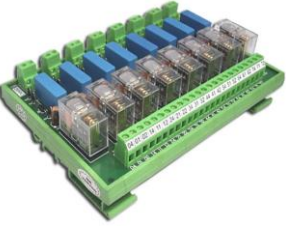

Battery Charger HSN : 85044030	Input	Output		Order Code	MRP (₹ each)	Availability (UR : Upon Request)
		Voltage DC	Current at Nominal Input			
 120W http://www.shavison.com/pdf/D1000.pdf	Nominal : 230VAC With Fan	12V	10A	BCW-1210	2630	Ex Stock
		24V	5A	BCW-2405	2470	Ex Stock
	Nominal : 230VAC Without Fan	48V	2A	BCW-4802	2990	UR
Nominal : 230VAC		12V	20A	BCD-1220	5320	UR
	24V	10A	BCD-2410	5270	Ex Stock	
	36V	6A	BCD-3606	5520	UR	
	48V	5A	BCD-4805	5340	UR	
 500W http://www.shavison.com/pdf/D3000.pdf	Nominal : 230VAC	24V	20A	BCD-2420	8350	Ex Stock
		36V	13A	BCD-3613	UR	UR
		48V	10A	BCD-4810	8970	UR
<ul style="list-style-type: none"> Automatic Boost and Float control Operates as FCBC or SMPS at Float voltage. 						



Voltage Monitor Relay HSN : 91070000	Operation	Input Range	Supply Voltage	Order Code	MRP (₹ each)	Availability (UR : Upon Request)
Applications : <ul style="list-style-type: none"> Voltage Monitoring Dynamic Braking Resistor Protection  Voltage Monitor Relay http://www.shavison.com/pdf/94000.pdf	<ul style="list-style-type: none"> Monitors DC input voltage and triggers internal timer when input voltage goes above set voltage. After Set time delay (0-60 sec), Relay change over occurs. Resets if input voltage comes down below set voltage 	0 – 10VDC Or 0 – 100VDC	85 – 270VAC	AS690-101	1150	UR
		0 – 50VDC Or 0 – 500VDC		AS690-102	1160	
		0 – 10VDC Or 0 – 100VDC	24VAC/DC	AS690-201	UR	
		0 – 50VDC Or 0 – 500VDC		AS690-202		







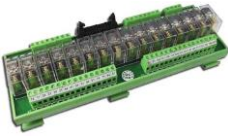

General Purpose Relay Modules <small>HSN : 85369090</small>	Description	Relay Socket	No. of Channels	Order Code	MRP (₹ each)	Availability (UR : Upon Request)
 1 C/O General Purpose http://www.shavison.com/pdf/G1000.pdf	<ul style="list-style-type: none"> • 1 C/O Contacts • 24VDC Coil • -Ve / +Ve or isolated looping by jumpers (site selectable) • OEN Relay 	Socket Mounted	4	GP04-1C-24V-S-OE	650	Ex Stock
			8	GP08-1C-24V-S-OE	1200	Ex Stock
			16	GP16-1C-24V-S-OE	2770	2 weeks
	<ul style="list-style-type: none"> • -Ve, +Ve or Isolated Coil looping can be done with the jumpers supplied with. 					
 2 C/O General Purpose http://www.shavison.com/pdf/G2000.pdf	<ul style="list-style-type: none"> • 2 C/O Contacts • 24VDC Coil • -Ve / +Ve or isolated looping by jumpers (site selectable) • OEN Relay 	Socket Mounted	4	GP04-2C-24V-S-OE	890	Ex Stock
			8	GP08-2C-24V-S-OE	1590	Ex Stock
	<ul style="list-style-type: none"> • -Ve, +Ve or Isolated Coil looping can be done with the jumpers supplied with. 					
 1 C/O Fuse at pole General Purpose http://www.shavison.com/pdf/G3000.pdf	<ul style="list-style-type: none"> • 1 C/O Contacts • 24VDC Coil • -Ve / +Ve or isolated looping by jumpers (site selectable) • OEN Relays 	Socket Mounted	4	GPF04-1C-24V-S-OE	920	2 weeks
			8	GPF08-1C-24V-S-OE	1730	2 weeks
	<ul style="list-style-type: none"> • -Ve, +Ve or Isolated Coil looping can be done with the jumpers supplied with. 					
Relay Modules <small>HSN : 85369090</small>  1 N/O Economy http://www.shavison.com/pdf/11100.pdf	<ul style="list-style-type: none"> • 1 N/O Contacts • Reverse blocking diode • -Ve looped • 24VDC Coil • OEN Relay 	Directly Soldered	4	AS383-24V-N-OE	680	MOQ : 50 3 Weeks
		8	AS385-24V-N-OE	1090		
		Socket Mounted	4	AS383-24V-N-S-OE	800	
		8	AS385-24V-N-S-OE	1240		
		<ul style="list-style-type: none"> • Availability & Prices for other relays (such as Omron G2RL) & coil voltages shall be quoted against specific request. • Order code shown above is for -Ve looped coils. Replace N with P for +Ve looping 				
 1 C/O Standard http://www.shavison.com/pdf/11200.pdf	<ul style="list-style-type: none"> • 1 C/O Contacts • Reverse blocking diode • 24VDC Coil • -Ve / +Ve or isolated looping by jumpers (site selectable) • OEN Relay 	Directly Soldered	1	AS361-24V-OE	210	Ex Stock
		2	AS362-24V-OE	410	Ex Stock	
		4	AS363-24V-OE	680	Ex Stock	
		8	AS365-24V-OE	1270	Ex Stock	
		12	AS366-24V-OE	UR	UR	
		16	AS367-24V-OE	UR	UR	
		Socket Mounted	1	AS361-24V-S-OE	230	Ex Stock
		2	AS362-24V-S-OE	430	Ex Stock	
		4	AS363-24V-S-OE	710	Ex Stock	
		8	AS365-24V-S-OE	1280	Ex Stock	
		12	AS366-24V-S-OE	UR	UR	
		16	AS367-24V-S-OE	UR	UR	
		<ul style="list-style-type: none"> • -Ve, +Ve or Isolated Coil looping can be done with the jumpers supplied with. • Availability & Prices for other relays (such as Omron G2RL) & coil voltages shall be quoted against specific request. 				

Relay Modules HSN : 85369090	Description	Relay Socket	No. of Channels	Order Code	MRP (₹ each)	Availability (UR : Upon Request)			
 <p>1 C/O Looped Coils http://www.shavison.com/pdf/11200.pdf</p>	<ul style="list-style-type: none"> • 1 C/O Contacts • Reverse blocking diode • -Ve looped (Factory set) 24VDC Coil OR +Ve looped • OEN Relay 	Directly Soldered	4	AS353-24V-N-OE	670	MOQ : 50 3 Weeks			
			8	AS355-24V-N-OE	1250				
			12	AS356-24V-N-OE	1900				
			16	AS357-24V-N-OE	2600				
		Socket Mounted	4	AS353-24V-N-S-OE	800				
			8	AS355-24V-N-S-OE	1380				
			12	AS356-24V-N-S-OE	2210				
			16	AS357-24V-N-S-OE	2890				
		<ul style="list-style-type: none"> • Availability & Prices for other relays (such as Omron G2RL) & coil voltages shall be quoted against specific request. • Order code shown above is for -Ve looped coils. Replace N with P for +Ve looping. Price remains same. 							
		 <p>1 C/O Sugar cube Looped Coils http://www.shavison.com/pdf/11200.pdf</p>	<ul style="list-style-type: none"> • 1 C/O Contacts • Reverse blocking diode • -Ve looped (Factory set) 24VDC Coil OR +Ve looped • OEN Relays 	Directly Soldered	1		AS401-24V-N-OE	UR	UR
2	AS402-24V-N- OE				UR	UR			
4	AS403-24V-N- OE				540	UR			
8	AS405-24V-N-OE				950	Ex Stock			
12	AS406-24V-N-OE				UR	UR			
16	AS407-24V-N-OE				UR	UR			
<ul style="list-style-type: none"> • Availability & Prices for other relays & coil voltages shall be quoted against specific request. • Order code shown above is for -Ve looped coils. Replace N with P for +Ve looping. Price remains same. Availability for -Ve looped coils is 3 Weeks. 									
 <p>1 C/O Sugar cube Isolated Coils http://www.shavison.com/pdf/11200.pdf</p>	<ul style="list-style-type: none"> • 1 C/O Contacts • Reverse blocking diode • 24VDC Coil • Isolated Coils • OEN Relays 	Directly Soldered	1	AS411-24V-OE	UR	UR			
			2	AS412-24V-OE	UR	UR			
			4	AS413-24V-OE	560	Ex Stock			
			8	AS415-24V-OE	1000	UR			
			12	AS416-24V-OE	UR	UR			
			16	AS417-24V-OE	UR	UR			
			<ul style="list-style-type: none"> • Availability & Prices for other relays & coil voltages shall be quoted against specific request. 						
 <p>1 C/O High Volt. Coils http://www.shavison.com/pdf/11200.pdf</p>	<ul style="list-style-type: none"> • 1 C/O Contacts • 230VAC Coil* • Isolated Coils • OEN Relays 	Directly Soldered	1	AS421-230VAC-OE	270	Ex Stock			
			2	AS422-230VAC-OE	530	Ex Stock			
			4	AS423-230VAC-OE	890	Ex Stock			
			6	AS424-230VAC-OE	1360	MOQ : 5, 3WK			
			8	AS425-230VAC-OE	1590	Ex Stock			
			16	AS427-230VAC-OE	3300	MOQ : 5, 3WK			
			Socket Mounted	1	AS421-230VAC-S-OE	290	Ex Stock		
				2	AS422-230VAC-S-OE	550	Ex Stock		
		4		AS423-230VAC-S-OE	990	Ex Stock			
		6		AS424-230VAC-S-OE	1470	MOQ : 5, 3WK			
		8		AS425-230VAC-S-OE	1780	Ex Stock			
		16		AS427-230VAC-S-OE	3680	MOQ : 5, 3WK			
		Socket Mounted		4	AS423-110VAC-S-OE	1010	MOQ : 5 3 Weeks		
				8	AS425-110VAC-S-OE	1890			
			16	AS427-110VAC-S-OE	3700				
			<ul style="list-style-type: none"> • 110VAC Coil* • *These modules are with basic relay of 24VDC coil along with suitable voltage converter. • Order Code shown above is for 230VAC coils. Replace 230VAC with other voltages 48VDC, 110VDC as required. • Availability & Prices for other relays (such as Omron G2RL) & coil voltages shall be quoted against specific request. 						
 <p>1 C/O 24VAC Coils http://www.shavison.com/pdf/11200.pdf</p>	<ul style="list-style-type: none"> • 1 C/O Contacts • 24VAC Coil* • Isolated Coils • OEN Relays 	Directly Soldered	1	AS621-24VAC-OE	280	2 Weeks			
			2	AS622-24VAC-OE	420				
			4	AS623-24VAC-OE	720				
			6	AS624-24VAC-OE	1020				
			8	AS625-24VAC-OE	1340				
		Socket Mounted	1	AS621-24VAC-S-OE	310				
			2	AS622-24VAC-S-OE	470				
			4	AS623-24VAC-S-OE	820				
			6	AS624-24VAC-S-OE	1170				
			8	AS625-24VAC-S-OE	1510				
<ul style="list-style-type: none"> • *These modules are with basic relay of 24VDC coil along with suitable voltage converter. • Availability & Prices for other relays (such as Omron G2RL) shall be quoted against specific request. 									

Relay Modules HSN : 85369090		Description	Relay Socket	No. of Channels	Order Code	MRP (₹ each)	Availability (UR : Upon Request)		
 <p>1 C/O Fuse at pole with Fuse Fail Indication</p> <p>http://www.shavison.com/pdf/11200.pdf</p>	<ul style="list-style-type: none"> • 1 C/O Contacts • Reverse blocking diode • -Ve looped (Factory set) 24VDC Coil OR +Ve looped • OEN Relays 	Directly Soldered	1	AS501-24V-N-OE-24VDC-2A	UR	UR			
			2	AS502-24V-N-OE-24VDC-2A		3 Weeks			
			4	AS503-24V-N-OE-24VDC-2A		3 Weeks			
			6	AS504-24V-N-OE-24VDC-2A		UR			
			8	AS505-24V-N-OE-24VDC-2A		3 Weeks			
			16	AS507-24V-N-OE-24VDC-2A		UR			
		Socket Mounted	1	AS501-24V-N-S-OE-24VDC-2A	UR	UR			
			2	AS502-24V-N-S-OE-24VDC-2A	620	3 Weeks			
			4	AS503-24V-N-S-OE-24VDC-2A	990	3 Weeks			
			6	AS504-24V-N-S-OE-24VDC-2A	UR	UR			
			8	AS505-24V-N-S-OE-24VDC-2A	1630	3 Weeks			
			16	AS507-24V-N-S-OE-24VDC-2A	UR	UR			
			<ul style="list-style-type: none"> • Order Code shown above is for -Ve looped coils, 24VDC Contact rating & 2A Fuse rating. Replace N with P for +Ve looping, 24VDC with 230V for 230VAC or 110VAC & 2A with 5A for 5 Amp fuse. Price remains same. • Availability & Prices for other relays (such as Omron G2RL) & coil voltages shall be quoted against specific request. 						
			 <p>1 C/O with High voltage Coil & Fuse at poles with Fuse Fail Indication</p> <p>http://www.shavison.com/pdf/11200.pdf</p>	<ul style="list-style-type: none"> • 1 C/O Contacts • 230VAC Coil* • Isolated Coils • OEN Relays 	Directly Soldered	1	AS801-230VAC-OE-24VDC-5A	360	UR
2	AS802-230VAC-OE-24VDC-5A	610				3 Weeks			
4	AS803-230VAC-OE-24VDC-5A	1060				3 Weeks			
8	AS805-230VAC-OE-24VDC-5A	UR				3 Weeks			
Socket Mounted	1	AS801-230VAC-S-OE-24VDC-5A			390	UR			
	2	AS802-230VAC-S-OE-24VDC-5A			630	3 Weeks			
	4	AS803-230VAC-S-OE-24VDC-5A			1160	3 Weeks			
	8	AS805-230VAC-S-OE-24VDC-5A			2230	3 Weeks			
Socket Mounted	4	AS803-110VAC-S-OE-24VDC-5A			1220	MOQ : 5			
	8	AS805-110VAC-S-OE-24VDC-5A			2320	3 Weeks			
<ul style="list-style-type: none"> • *These modules are with basic relay of 24VDC coil along with suitable voltage converter. • Order Code shown above is for 230VAC coils and 24VDC, 2A Contact Rating. Replace 24VDC with 230V for 230VAC or 110VAC Contact rating & Fuse rating as required. Price remains same. • Availability & Prices for other relays (such as Omron G2RL) & coil voltages shall be quoted against specific request. 									
Relay Modules HSN : 85369090		Description	Relay Socket	No. of Channels	Order Code	MRP (₹ each)	Availability (UR : Upon Request)		
 <p>1 C/O Space Saver</p> <p>http://www.shavison.com/pdf/11200.pdf</p>	<ul style="list-style-type: none"> • 1C/O Contacts • Reverse blocking diode • OEN Relays 	Directly Soldered	8	AS789-24V-N-OE (For -Ve looped coils)	1600	Ex Stock			
				AS789-24V-P-OE (For +Ve looped coils)	1600	3 Weeks			
				<ul style="list-style-type: none"> • Availability & Prices for other relays (such as Omron G2RL) & coil voltages shall be quoted against specific request for quantities above 50 Nos. • Order code shown above is for -Ve looped coils. Replace N with P for +Ve looping. 					
Relay Modules HSN : 85369090		Description	Relay Socket	No. of Channels	Order Code	MRP (₹ each)	Availability (UR : Upon Request)		
 <p>2 C/O Standard</p> <p>http://www.shavison.com/pdf/11300.pdf</p>	<ul style="list-style-type: none"> • 2 C/O Contacts • Reverse blocking diode • 24VDC Coil • -Ve / +Ve or isolated looping by jumpers (site selectable) • OEN Relay 	Directly Soldered	1	AS391-24V-OE	240	Ex Stock			
			2	AS392-24V-OE	450	Ex Stock			
			4	AS393-24V-OE	840	Ex Stock			
			8	AS395-24V-OE	1500	Ex Stock			
			12	AS396-24V-OE	UR	UR			
			16	AS397-24V-OE	UR	UR			
		Socket Mounted	1	AS391-24V-S-OE	260	Ex Stock			
			2	AS392-24V-S-OE	510	Ex Stock			
			4	AS393-24V-S-OE	950	Ex Stock			
			8	AS395-24V-S-OE	1690	Ex Stock			
			12	AS396-24V-S-OE	UR	UR			
			16	AS397-24V-S-OE	UR	UR			
<ul style="list-style-type: none"> • -Ve, +Ve or Isolated Coil looping can be done with the jumpers supplied with. • Availability & Prices for other relays (such as Omron G2RL) & coil voltages shall be quoted against specific request. 									





Relay Modules HSN : 85369090	Description	Relay Socket	No. of Channels	Order Code	MRP (₹ each)	Availability (UR : Upon Request)			
 <p>2 C/O Looped Coils</p> <p>http://www.shavison.com/pdf/11300.pdf</p>	<ul style="list-style-type: none"> • 2 C/O Contacts • Reverse blocking diode • -Ve looped (Factory set) 24VDC Coil OR +Ve looped • OEN Relay 	Directly Soldered	4	AS373-24V-N-OE	UR	MOQ : 50 3 Weeks			
			8	AS375-24V-N-OE	1510				
			12	AS376-24V-N-OE	UR				
			16	AS377-24V-N-OE	3140				
		Socket Mounted	4	AS373-24V-N-S-OE	UR				
			8	AS375-24V-N-S-OE	1720				
			12	AS376-24V-N-S-OE	UR				
			16	AS377-24V-N-S-OE	3540				
		<ul style="list-style-type: none"> • Availability & Prices for other relays (such as Omron G2RL) & coil voltages shall be quoted against specific request. • Order code shown above is for -Ve looped coils. Replace N with P for +Ve looping. Price remains same. 							
		 <p>2 C/O High Voltage Coils</p> <p>http://www.shavison.com/pdf/11300.pdf</p>	<ul style="list-style-type: none"> • 2 C/O Contacts • 230VAC Coil* • Isolated Coils • OEN Relays 	Directly Soldered	1		AS431-230VAC-OE	320	Ex Stock
2	AS432-230VAC-OE				650	Ex Stock			
4	AS433-230VAC-OE				1070	Ex Stock			
8	AS435-230VAC-OE				1910	Ex Stock			
Socket Mounted	1			AS431-230VAC-S-OE	340	Ex Stock			
	2			AS432-230VAC-S-OE	670	Ex Stock			
	4			AS433-230VAC-S-OE	1150	Ex Stock			
	8			AS435-230VAC-S-OE	2040	Ex Stock			
Socket Mounted	4			AS433-110VAC-S-OE	1190	MOQ : 5 3 Weeks			
	8			AS435-110VAC-S-OE	2160				
<ul style="list-style-type: none"> • *These modules are with basic relay of 24VDC coil along with suitable voltage converter. • Order Code shown above is for 230VAC coils. Replace 230VAC with other voltages 24VAC, 48VDC, 110VDC as required. • Availability & Prices for other relays (such as Omron G2RL) & coil voltages shall be quoted against specific request. 									

Relay Modules Special HSN : 85369090	Description	Relay Socket	No. of Channels	Order Code	MRP (₹ each)	Availability (UR : Upon Request)
 <p>Coil Connection through FRC / HE 10</p> <p>http://www.shavison.com/pdf/12100.pdf</p>	<ul style="list-style-type: none"> • 1N/O Contacts • Reverse blocking diode • -Ve looped (Factory set) 24VDC Coil • OEN Relays 	Directly Soldered	16	AS334-24V-N-OE	2300	3 Weeks
		Socket Mounted		AS334-24V-N-S-OE	2720	3 Weeks
		<ul style="list-style-type: none"> • Availability & Prices for other relays (such as Omron G2RL) & coil voltages shall be quoted against specific request. • Order code shown above is for -Ve looped coils. Replace N with P for +Ve looping. Price remains same. 				
 <p>1 C/O 30A Contacts</p> <p>http://www.shavison.com/pdf/12500.pdf</p>	<ul style="list-style-type: none"> • 1C/O Contacts Rated for 30 Amps • Reverse blocking diode • Isolated Coils 	Directly Soldered	1	AS548-101-12V	420	2 Weeks
			AS548-101-24V	390		
		2	AS548-102-12V	560		
			AS548-102-24V	530		
<ul style="list-style-type: none"> • Availability & Prices for other relays & coil voltages shall be quoted against specific request. • Sun hold, Leone or equivalent relays. 						
 <p>1 C/O 30A Contacts High Voltage Coils</p> <p>http://www.shavison.com/pdf/12F00.pdf</p>	<ul style="list-style-type: none"> • 1C/O Contacts Rated for 30 Amps • 230VAC Coil * • Isolated Coils 	Directly Soldered	1	AS701-230VAC-30A	410	2 Weeks
			2	AS702-230VAC-30A	UR	UR
			4	AS703-230VAC-30A	UR	
			6	AS704-230VAC-30A	UR	
			8	AS705-230VAC-30A	UR	
		<ul style="list-style-type: none"> • *These modules are with basic relay of 24VDC coil along with suitable voltage converter. • Order Code shown above is for 230VAC coils. Replace 230VAC with other voltages 48VDC, 110VDC, 110VAC as required. Price remains same. 				

Relay Modules Special HSN : 85369090	Description	Relay Socket	No. of Channels	Order Code	MRP (₹ each)	Availability (UR : Upon Request)
 <p>Generator Control Interface http://www.shavison.com/pdf/12F10.pdf</p>	<ul style="list-style-type: none"> • 1 N/O 70A rated Contacts • 1 C/O 5A rated Contacts • Reverse Blocking Diode 	Directly Soldered	4	AS547-101 (12VDC Coil)	1060	UR
				AS547-102 (24VDC Coil)	1440	UR
 <p>2 C/O, High Sensitivity http://www.shavison.com/pdf/12E00.pdf</p>	<ul style="list-style-type: none"> • 2 C/O Contacts • Signal Relays • Reverse Blocking Diode • 24VDC Coil • Coil looping by jumpers 	Directly Soldered	2	AS682-24V-G5V	850	UR
			4	AS683-24V-G5V	1500	UR
<ul style="list-style-type: none"> • Suitable for analog and digital signals of low voltage & low current. • Availability & Prices for other relays & coil voltages shall be quoted against specific request. 						
 <p>1 N/O with Coil Thru FRC http://www.shavison.com/pdf/12400.pdf</p>	<ul style="list-style-type: none"> • 1 N/O Contacts • Coil Conn. Through FRC • Reverse Blocking Diode • OEN Relay 	Directly Soldered	8	AS298-101	UR	UR
 <p>CNC Specific Relay Module http://www.shavison.com/pdf/12C00.pdf</p>	Description	Relay Socket	Order Code	MRP (₹ each)	Availability (UR : Upon Request)	
	<ul style="list-style-type: none"> • 50 pin Male FRC Conn. • 24 Inputs, 24VDC each • 16 channel, 1 C/O Relays • OEN Relay 	Directly Soldered	AS717-OE	UR	UR	
		Socket Mounted	AS717-S-OE	3370	3 Weeks	
<ul style="list-style-type: none"> • Availability & Prices for other relays (such as Omron G2RL) & coil voltages shall be quoted against specific request. 						
 <p>2 C/O, with FRC conn. Input & Cascading http://www.shavison.com/pdf/12900.pdf</p>	<ul style="list-style-type: none"> • 8 Relays • 2 C/O Contacts • +Ve looped • 24VDC Coil • OEN Relay 	Directly Soldered	AS296-24V-OE	1790	3 Weeks	
		Socket Mounted	AS296-24V-S-OE	UR	UR	
<ul style="list-style-type: none"> • Availability & Prices for other relays (such as Omron G2RL) & coil voltages shall be quoted against specific request. 						
 <p>1 C/O TTL/Low current input http://www.shavison.com/pdf/12600.pdf</p>	Description	Input	Aux. (Coil) Voltage	Order Code	MRP (₹ each)	Availability (UR : Upon Request)
	<ul style="list-style-type: none"> • 4 Relays • 8 Relays • 1 C/O Contacts • TTL/Low current Input • OEN Relay 	5V, 1mA	24V	AS253-5V-24V-OE	980	3 Weeks
			12V	AS254-5V-12V-OE	1790	
		24V, 5mA	24V	AS254-5V-24V-OE	1580	
			12V	AS254-24V-12V-OE	1780	
24V			AS254-24V-24V-OE	1590		
<ul style="list-style-type: none"> • <i>Input & Aux. are not isolated from each other.</i> • Availability & Prices for other relays (such as Omron G2RL) & coil voltages shall be quoted against specific request. 						
 <p>1 C/O, Low Signal Relays, TTL/Low current input http://www.shavison.com/pdf/12D00.pdf</p>	<ul style="list-style-type: none"> • 8 Relays • 1 C/O Contacts • TTL/Low current Input • Low Signal Relays • Omron G5V-1 Relay 	5V, 1mA	24V	AS535-5V-24V-G5V	2360	3 Weeks
		24V, 5mA	24V	AS535-24V-24V-G5V	2350	
<ul style="list-style-type: none"> • <i>Input & Aux. are not isolated from each other.</i> • Availability & Prices for other coil voltages shall be quoted against specific request. 						
 <p>2 C/O, TTL/Low current input http://www.shavison.com/pdf/12700.pdf</p>	<ul style="list-style-type: none"> • 8 Relays • 2 C/O Contacts • TTL/Low current Input • OEN Relay 	5V, 1mA	12V	AS339-5V-12V-OE	2120	3 Weeks
			24V	AS339-5V-24V-OE	1850	
		24V, 5mA	12V	AS339-24V-12V-OE	2120	
			24V	AS339-24V-24V-OE	1850	
<ul style="list-style-type: none"> • <i>Input & Aux. are not isolated from each other.</i> • Availability & Prices for other relays (such as Omron G2RL) & coil voltages shall be quoted against specific request. 						

Relay Modules Special HSN : 85369090	Description	Input	Aux.(Coil) Voltage	Order Code	MRP (₹ each)	Availability (UR : Upon Request)
 <p>2 C/O, With opto input http://www.shavison.com/pdf/12800.pdf</p>	<ul style="list-style-type: none"> • 4 Relays • 2 C/O Contacts • Opto Input 10mA • OEN Relay 	5V	12V	AS720-5V-12V-OE	1530	UR
			24V	AS720-5V-24V-OE	1160	3 Weeks
		24V	12V	AS720-24V-12V-OE	1530	UR
			24V	AS720-24V-24V-OE	1160	3 Weeks
<ul style="list-style-type: none"> • Availability & Prices for other relays (such as Omron G2RL) & opto Input shall be quoted against specific request. 						







Refer page 16 for opto interface modules







Isolated : SSR HSN : 85369090	Description	No. of Channels	Input Voltage	Order Code	MRP (₹ each)	Availability (UR : Upon Request)
 <p>(Solenoid Driver) SSR : DC - DC http://www.shavison.com/pdf/13310.pdf</p>	<ul style="list-style-type: none"> • Life 100 times more than electro mech. Relay • Input current <10mA • Output 12V ~ 48VDC, 1.5A • Operating Freq. upto 10KHz • Fuse at output 	4	3.3 ~ 30V	AS893-101	920	3 Weeks
		8	3.3 ~ 30V	AS895-101	1690	3 Weeks
		<ul style="list-style-type: none"> • Availability & Prices for other channels (viz. 6, 12, 16) shall be quoted against specific request. 				
 <p>SSR : DC - DC http://www.shavison.com/pdf/13110.pdf</p>	<ul style="list-style-type: none"> • Optical Isolation between I/O • Input current <15mA • Output 24VDC, 2A • Operating Freq. upto 10KHz • <i>Not recommended for Inductive Loads</i> 	2	12V	AS782-12V-24V	710	3 Weeks
			24V	AS782-24V-24V	670	Ex Stock
		4	12V	AS783-12V-24V	860	3 Weeks
			24V	AS783-24V-24V	830	Ex Stock
		8	12V	AS785-12V-24V	1310	3 Weeks
			24V	AS785-24V-24V	1250	Ex Stock
<ul style="list-style-type: none"> • Availability & Prices for other channels (viz. 6, 12, 16) & Input voltages (viz. 5V, 12V) shall be quoted against specific request. 						
 <p>SSR : DC - AC http://www.shavison.com/pdf/13120.pdf</p>	<ul style="list-style-type: none"> • Optical Isolation between I/O • Input current 15mA • Output 70-270VAC, 2A • Operating Freq. upto 25Hz • Fuse at output 	2	12V	AS792-12V-230VAC-2A	UR	UR
			24V	AS792-24V-230VAC-2A	930	3 Weeks
		4	12V	AS793-12V-230VAC-2A	1310	3 Weeks
			24V	AS793-24V-230VAC-2A	1300	Ex Stock
		8	12V	AS795-12V-230VAC-2A	2110	3 Weeks
			24V	AS795-24V-230VAC-2A	2090	Ex Stock
<ul style="list-style-type: none"> • Availability & Prices for other channels (viz. 6, 12, 16) & Input voltages (viz. 5V, 12V) shall be quoted against specific request. 						
Non-Isolated : SSR HSN : 85369090	Description	No. of Channels	Input Voltage	Order Code	MRP (₹ each)	Availability (UR : Upon Request)
 <p>(Solenoid Driver) SSR : DC - DC http://www.shavison.com/pdf/13210.pdf</p>	<ul style="list-style-type: none"> • Life 100 times more than electro mech. Relay • Input current 15mA • High/Low Input selection with jumpers (site selectable) • Output 24VDC, 2.5A • Operating Freq. upto 10KHz • Fuse at output 	2	12V	AS772-12V-24V	660	3 Weeks
			24V	AS772-24V-24V	510	Ex Stock
		4	12V	AS773-12V-24V	1080	3 Weeks
			24V	AS773-24V-24V	840	Ex Stock
		8	12V	AS775-12V-24V	1580	3 Weeks
			24V	AS775-24V-24V	1490	Ex Stock
<ul style="list-style-type: none"> • Availability & Prices for other channels (viz. 6, 12, 16) shall be quoted against specific request. 						

Shavison Electronics Pvt. Ltd.

Boardlines : +91-251-2620417, 2620427, +91-9820 362 980, 72648 90900

Email : shavison@shavison.com Website : www.shavison.com

High Frequency Opto Interface Module HSN : 85369090	Features	Input Voltage	Order Code	MRP (₹ each)	Availability (UR : Upon Request)		
 <p>Operating Frequency : Upto 200 KHz http://www.shavison.com/pdf/14200.pdf</p>	<ul style="list-style-type: none"> 4 Channel Optical Isolation between Input & Output Aux Supply : 24VDC Wide Input Voltage Range High Speed Operation upto 200KHz 24V Output or Open Collector Compatible with PNP & NPN type Inputs Suitable for Microcontroller based Application 	3~12V	AS923-101	1100	Ex Stock		
		12~30V	AS923-102	1130	UR		
Opto Interface HSN : 85369090	Description	No. of Channels	Input Voltage	Order Code	MRP (₹ each)	Availability (UR : Upon Request)	
 <p>DC Input Opto Isolator/Level Shifter / NPN / PNP Converter http://www.shavison.com/pdf/14000.pdf</p>	<ul style="list-style-type: none"> Optical Isolation between I/O Input current < 15mA Output 5V-30VDC, 15mA 	2	12V	AS522-12V	310	3 Weeks	
			24V	AS522-24V	260	Ex Stock	
		4	12V	AS523-12V	560	3 Weeks	
			24V	AS523-24V	540	Ex Stock	
		8	3.3V**	AS525-3.3V	890	3 Weeks	
			12V	AS525-12V	880	3 Weeks	
			24V	AS525-24V	850	Ex Stock	
			1.3 ~ 1.8V**	AS525-152	910	3 Weeks	
		<ul style="list-style-type: none"> Availability & Prices for other channels (viz. 6, 12, 16) & Input voltages (viz. 5V, 15V) shall be quoted against specific request. ** : No Input LED Indication 					
		 <p>AC Input Opto Isolator http://www.shavison.com/pdf/14100.pdf</p>		2	230VAC	AS852-230VAC	450
4	230VAC			AS853-230VAC	600	3 Weeks	
8	230VAC			AS855-230VAC	1030	3 Weeks	
<ul style="list-style-type: none"> Availability & Prices for other channels (viz. 6, 12, 16) & Input voltages shall be quoted against specific request. 							
FRC / D-SUB (M/F) Terminators HSN : 85369090	Description	No. of Pins	Order Code	MRP (₹ each)	Availability (UR : Upon Request)		
 <p>FRC to Screw Terminator http://www.shavison.com/pdf/15000.pdf</p>	<ul style="list-style-type: none"> Voltage Rating : 100VDC Current Rating : 500mA 	10	AS581	210	Ex Stock		
		14	AS582	240			
		16	AS583	280			
		20	AS584	330			
		26	AS585	380			
		34	AS586	490			
		40	AS587	540			
		50	AS588	680			
		60	AS589	780			
 <p>DSUB to Screw Terminator http://www.shavison.com/pdf/15000.pdf</p>	<ul style="list-style-type: none"> Voltage Rating : 100VDC Current Rating : 500mA 	9	AS591-M	260	Ex Stock		
		15	AS592-M	330			
		25	AS593-M	470			
		37	AS594-M	680			
		50 (3 row)	AS595-M-3 ROW	850			
<ul style="list-style-type: none"> Order Code shown above is for Male DSUB Connector. Replace M with F for Female DSUB connector. 							
CABLES FRC / D-SUB (M/F) HSN : 85369090	Description	No. of Pins	Length	Order Code	MRP (₹ each)	Availability (UR : Upon Request)	
 <p>FRC http://www.shavison.com/pdf/15000.pdf</p>	<ul style="list-style-type: none"> Flat Ribbon Cable Current Rating : 500mA Available lengths : 1M, 2.5M, 5M, 10M 	10	1 meter	WA-FRC-10P-1M	UR	1 Week	
		14		WA-FRC-14P-1M			
		16		WA-FRC-16P-1M			
		20		WA-FRC-20P-1M	80		
		26		WA-FRC-26P-1M	UR		
		34		WA-FRC-34P-1M			
		40		WA-FRC-40P-1M			160
		50		WA-FRC-50P-1M	UR		
		60		WA-FRC-60P-1M			
		64		WA-FRC-64P-1M			
<ul style="list-style-type: none"> Order Code shown above is for straight cable with 1 meter length. Replace WA with WAR for reverse polarity and suffix -1M for other lengths. Availability & Prices for other lengths shall be quoted against specific request. 							

CABLES FRC / D-SUB (M/F) HSN : 85369090	Description	No. of Pins	Length	Order Code	MRP (₹ each)	Availability (UR : Upon Request)
 DSUB Cable http://www.shavison.com/pdf/15000.pdf	<ul style="list-style-type: none"> DSUB to DSUB Connector Cable Current Rating : 500mA 	9	1 meter ¹	WA-DSUB-9P-MM-1M-NS	UR	2 Weeks
		15		WA-DSUB-15P-MM-1M-NS		
		25		WA-DSUB-25P-MM-1M-NS		
		37		WA-DSUB-37P-MM-1M-NS		
		50 (3 row)		WA-DSUB-50P-MM-1M-NS		
		<ul style="list-style-type: none"> Order Code shown above is for non-shielded cable (suffix -NS) with Male type connector at both ends. Note 1 : Order Code shown above is for 1 meter long cable. Replace suffix -1M for other lengths. (Viz. 2.5M, 5M, 10M) Availability & Prices for other lengths shall be quoted against specific request. Refer datasheet for other order codes. 				
Proximity Sensor Interface HSN : 85369090	Description	No. of Channels	Order Code	MRP (₹ each)	Availability (UR : Upon Request)	
 Proximity Sensor Interface http://www.shavison.com/pdf/93000.pdf	<ul style="list-style-type: none"> PNP, NPN or Bipolar Indication by Jumpers 24VDC Input 	1	AS441-24V	UR	UR	
		2	AS442-24V	290	2 Weeks	
		4	AS443-24V	420	2 Weeks	
		6	AS444-24V	UR	UR	
		8	AS445-24V	670	2 Weeks	
		<ul style="list-style-type: none"> Order code shown above is for Common Anode and 3 Amp current rating. Replace CA with CK for Common Cathode. Availability & Prices for other channels shall be quoted against specific request. 				
Diode / Resistor Modules HSN : 85369090	Description	No. of Diodes / Resistors	Order Code	MRP (₹ each)	Availability (UR : Upon Request)	
 Diode Module common type http://www.shavison.com/pdf/17000.pdf	<ul style="list-style-type: none"> Common Anode / Cathode Common Terminal rating 10A Max 	2	AS601-CA-3A	UR	UR	
		4	AS602-CA-3A	240		
		8	AS603-CA-3A	280		
		16	AS604-CA-3A	440		
		<ul style="list-style-type: none"> Order code shown above is for Common Anode and 3 Amp current rating. Replace CA with CK for Common Cathode. Availability & Prices for other channels shall be quoted against specific request. 				
 Modules with Resistors http://www.shavison.com/pdf/17000.pdf	<ul style="list-style-type: none"> Bussed Resistors As per specifications Common Terminal rating 10A max. 	2	AS601-***	UR	UR	
		4	AS602-***			
		8	AS603-***			
		16	AS604-***			
		<ul style="list-style-type: none"> Provision for QW resistors. Availability & Prices for other channels shall be quoted against specific request. AS601-100, AS602-100, AS603-100 Models are available with terminals, PCB and DIN Rail Mount Hardware. No components included. 				
 Diode Module oring type http://www.shavison.com/pdf/17000.pdf	<ul style="list-style-type: none"> Common Anode / Cathode Common Terminal rating 10A Max 	1	AS606-CA-1A	UR	UR	
		2	AS607-CA-1A	UR		
		4	AS608-CA-1A	320		
		8	AS609-CA-1A	470		
		<ul style="list-style-type: none"> Order code shown above is for Common Anode and 1 Amp current rating. Replace CA with CK for Common Cathode. Availability & Prices for other channels shall be quoted against specific request. 				
 Modules with Resistors http://www.shavison.com/pdf/17000.pdf	<ul style="list-style-type: none"> Dual Resistors As per specifications Common Terminal rating 10A max. 	1	AS606-***	UR	UR	
		2	AS607-***			
		4	AS608-***			
		8	AS609-***			
		<ul style="list-style-type: none"> Provision for QW resistors. Availability & Prices for other channels shall be quoted against specific request. AS606-100, AS607-100, AS608-100, AS609-100 Models are available with terminals, PCB and DIN Rail Mount Hardware. No components included. 				
Vibrator Control Card HSN : 85437099	Description	Order Code	MRP (₹ each)	Availability (UR : Upon Request)		
 Half wave phase controlled DC output http://www.shavison.com/pdf/92000.pdf	<ul style="list-style-type: none"> Input : 230VAC, 47-63 Hz Output : Half wave phase controlled DC, 2A max. Presets to set Coarse and fine control Facility to connect external potentiometer or external 0 to 10VDC DIN Rail Mountable 	AS780-101	2360	3 Weeks		

Price List

wef 1st Apr 2023



Precision Reference Source HSN : 85044090	Description	Table ¹		Order Code	MRP (₹ each)	Availability (UR : Upon Request)
		Linear Pot Value	No. of Pots			
 10VDC : 20mA http://www.shavison.com/pdf/50000.pdf	Input : Nominal : 230VAC Input Range : 180 – 270VAC Output : 10VDC : 20mA	1K	2	G31-24-10	890	Ex Stock
		2K	4			
		5K	10			
		10K	20			
• Note: Multiple no. of pots can be connected as shown in Table ¹ .						

Analog Signal Converters HSN : 85437099	Input	Output 1	Output 2	Order Code		MRP (₹ each)	Availability (UR : Upon Request)
				Aux Supply			
				90 ~ 270V AC	18 ~ 36V DC		
Input : Multi Input							
DC Voltage : 0 - 10VDC Potentiometer : 1K-10K DC Current : 4-20mA (2 Wire Source Type) 0-20mA (2 Wire Source Type)	0 - 5/10VDC	0 - 5/10VDC	0 - 5/10VDC	SC2-M01-A-A-U	SC2-M01-A-A-24V	2790	Ex Stock
	0 - 5/10VDC	0/4 - 20mA	0/4 - 20mA	SC2-M01-A-B-U	SC2-M01-A-B-24V		
	0/4 - 20mA	0/4 - 20mA	0/4 - 20mA	SC2-M01-B-B-U	SC2-M01-B-B-24V		
Input : DC Voltage							
0 - 5mV 0 - 10mV	0 - 5/10VDC	0 - 5/10VDC	0 - 5/10VDC	SC2-V01-A-A-U	SC2-V01-A-A-24V	UR	UR
	0 - 5/10VDC	0/4 - 20mA	0/4 - 20mA	SC2-V01-A-B-U	SC2-V01-A-B-24V		
	0/4 - 20mA	0/4 - 20mA	0/4 - 20mA	SC2-V01-B-B-U	SC2-V01-B-B-24V		
0 - 20mV# 0 - 50mV	0 - 5/10VDC	0 - 5/10VDC	0 - 5/10VDC	SC2-V02-A-A-U	SC2-V02-A-A-24V	UR	UR
	0 - 5/10VDC	0/4 - 20mA	0/4 - 20mA	SC2-V02-A-B-U	SC2-V02-A-B-24V		
	0/4 - 20mA	0/4 - 20mA	0/4 - 20mA	SC2-V02-B-B-U	SC2-V02-B-B-24V		
• # : Not suitable for Load cell Application.							
0 - 60mV 0 - 75mV	0 - 5/10VDC	0 - 5/10VDC	0 - 5/10VDC	SC2-V03-A-A-U	SC2-V03-A-A-24V	2770	2 Weeks
	0 - 5/10VDC	0/4 - 20mA	0/4 - 20mA	SC2-V03-A-B-U	SC2-V03-A-B-24V		
	0/4 - 20mA	0/4 - 20mA	0/4 - 20mA	SC2-V03-B-B-U	SC2-V03-B-B-24V		
0 - 100mV 0 - 200mV 0 - 300mV 0 - 400mV	0 - 5/10VDC	0 - 5/10VDC	0 - 5/10VDC	SC2-V11-A-A-U	SC2-V11-A-A-24V	2740	2 Weeks
	0 - 5/10VDC	0/4 - 20mA	0/4 - 20mA	SC2-V11-A-B-U	SC2-V11-A-B-24V		
	0/4 - 20mA	0/4 - 20mA	0/4 - 20mA	SC2-V11-B-B-U	SC2-V11-B-B-24V		
0 - 500mV 0 - 600mV 0 - 800mV 0 - 1V	0 - 5/10VDC	0 - 5/10VDC	0 - 5/10VDC	SC2-V12-A-A-U	SC2-V12-A-A-24V	2740	2 Weeks
	0 - 5/10VDC	0/4 - 20mA	0/4 - 20mA	SC2-V12-A-B-U	SC2-V12-A-B-24V		
	0/4 - 20mA	0/4 - 20mA	0/4 - 20mA	SC2-V12-B-B-U	SC2-V12-B-B-24V		
0 - 2V 0 - 2.5V 0 - 5V 0 - 8V	0 - 5/10VDC	0 - 5/10VDC	0 - 5/10VDC	SC2-V13-A-A-U	SC2-V13-A-A-24V	2740	2 Weeks
	0 - 5/10VDC	0/4 - 20mA	0/4 - 20mA	SC2-V13-A-B-U	SC2-V13-A-B-24V		
	0/4 - 20mA	0/4 - 20mA	0/4 - 20mA	SC2-V13-B-B-U	SC2-V13-B-B-24V		
0 - 15V 0 - 20V 0 - 25V 0 - 30V	0 - 5/10VDC	0 - 5/10VDC	0 - 5/10VDC	SC2-V14-A-A-U	SC2-V14-A-A-24V	2740	2 Weeks
	0 - 5/10VDC	0/4 - 20mA	0/4 - 20mA	SC2-V14-A-B-U	SC2-V14-A-B-24V		
	0/4 - 20mA	0/4 - 20mA	0/4 - 20mA	SC2-V14-B-B-U	SC2-V14-B-B-24V		
0 - 40V 0 - 50V 0 - 60V 0 - 70V	0 - 5/10VDC	0 - 5/10VDC	0 - 5/10VDC	SC2-V15-A-A-U	SC2-V15-A-A-24V	2740	2 Weeks
	0 - 5/10VDC	0/4 - 20mA	0/4 - 20mA	SC2-V15-A-B-U	SC2-V15-A-B-24V		
	0/4 - 20mA	0/4 - 20mA	0/4 - 20mA	SC2-V15-B-B-U	SC2-V15-B-B-24V		
0 - 75V 0 - 80V 0 - 100V 0 - 120V	0 - 5/10VDC	0 - 5/10VDC	0 - 5/10VDC	SC2-V16-A-A-U	SC2-V16-A-A-24V	2740	2 Weeks
	0 - 5/10VDC	0/4 - 20mA	0/4 - 20mA	SC2-V16-A-B-U	SC2-V16-A-B-24V		
	0/4 - 20mA	0/4 - 20mA	0/4 - 20mA	SC2-V16-B-B-U	SC2-V16-B-B-24V		
0 - 150V 0 - 200V 0 - 250V 0 - 300V	0 - 5/10VDC	0 - 5/10VDC	0 - 5/10VDC	SC2-V17-A-A-U	SC2-V17-A-A-24V	2740	2 Weeks
	0 - 5/10VDC	0/4 - 20mA	0/4 - 20mA	SC2-V17-A-B-U	SC2-V17-A-B-24V		
	0/4 - 20mA	0/4 - 20mA	0/4 - 20mA	SC2-V17-B-B-U	SC2-V17-B-B-24V		
Input : Current (mA DC)							
0 - 20mA 4 - 20mA (2 Wire / 4 Wire)	0 - 5/10VDC	0 - 5/10VDC	0 - 5/10VDC	SC2-I01-A-A-U	SC2-I01-A-A-24V	2740	1 week
	0 - 5/10VDC	0/4 - 20mA	0/4 - 20mA	SC2-I01-A-B-U	SC2-I01-A-B-24V		
	0/4 - 20mA	0/4 - 20mA	0/4 - 20mA	SC2-I01-B-B-U	SC2-I01-B-B-24V		
0 - 50mA 0 - 100mA	0 - 5/10VDC	0 - 5/10VDC	0 - 5/10VDC	SC2-I02-A-A-U	SC2-I02-A-A-24V	2800	UR
	0 - 5/10VDC	0/4 - 20mA	0/4 - 20mA	SC2-I02-A-B-U	SC2-I02-A-B-24V		
	0/4 - 20mA	0/4 - 20mA	0/4 - 20mA	SC2-I02-B-B-U	SC2-I02-B-B-24V		
• Refer datasheet for more details.							



SC2 Series

Dual Isolated Output

<http://www.shavison.com/pdf/63100.pdf>

Analog Signal Converters HSN : 85437099	Input	Output 1	Output 2	Order Code		MRP (₹ each)	Availability (UR : Upon Request)
				Aux Supply			
				90 ~ 270V AC	18 ~ 36V DC		
Input : Current (Amp AC)							
0 – 1A AC	0 - 10VDC	0 - 10VDC	AS865-101	AS865-501	3070	UR	
	4 - 20mA	0 - 10VDC	AS865-102	AS865-502			
	4 - 20mA	4 - 20mA	AS865-103	AS865-503			
0 – 5A AC	0 - 10VDC	0 - 10VDC	AS865-104	AS865-504			
	4 - 20mA	0 - 10VDC	AS865-105	AS865-505			
	4 - 20mA	4 - 20mA	AS865-106	AS865-506			
Input : Thermocouple K Type							
-200 to +200°C	0 - 10VDC	0 - 10VDC	AS845-215	AS845-615	2840	UR	
	4 - 20mA	0 - 10VDC	AS845-216	AS845-616			
	4 - 20mA	4 - 20mA	AS845-217	AS845-617			
-200 to +200°C	0 - 10VDC	0 - 10VDC	AS845-218	AS845-618			
	4 - 20mA	0 - 10VDC	AS845-219	AS845-619			
	4 - 20mA	4 - 20mA	AS845-220	AS845-620			
0 to 100°C	0 - 10VDC	0 - 10VDC	AS845-221	AS845-621			
	4 - 20mA	0 - 10VDC	AS845-222	AS845-622			
	4 - 20mA	4 - 20mA	AS845-223	AS845-623			
0 to 200°C	0 - 10VDC	0 - 10VDC	AS845-224	AS845-624			
	4 - 20mA	0 - 10VDC	AS845-225	AS845-625			
	4 - 20mA	4 - 20mA	AS845-226	AS845-626			
0 to 250°C	4 - 20mA	0 - 5VDC	AS845-248	AS845-648			
	4 - 20mA	4 - 20mA	AS845-249	AS845-649			
0 to 300°C	0 - 10VDC	0 - 10VDC	AS845-227	AS845-627			
	4 - 20mA	0 - 10VDC	AS845-228	AS845-628			
	4 - 20mA	4 - 20mA	AS845-229	AS845-629			
0 to 400°C	0 - 10VDC	0 - 10VDC	AS845-230	AS845-630			
	4 - 20mA	0 - 10VDC	AS845-231	AS845-631			
	4 - 20mA	4 - 20mA	AS845-232	AS845-632			
0 to 500°C	0 - 10VDC	0 - 10VDC	AS845-233	AS845-633			
	4 - 20mA	0 - 10VDC	AS845-234	AS845-634			
	4 - 20mA	4 - 20mA	AS845-235	AS845-635			
0 to 800°C	0 - 10VDC	0 - 10VDC	AS845-239	AS845-639			
	4 - 20mA	0 - 10VDC	AS845-240	AS845-640			
	4 - 20mA	4 - 20mA	AS845-241	AS845-641			
0 to 1000°C	0 - 10VDC	0 - 10VDC	AS845-242	AS845-642			
	4 - 20mA	0 - 10VDC	AS845-243	AS845-643			
	4 - 20mA	4 - 20mA	AS845-244	AS845-644			
0 to 1200°C	0 - 10VDC	0 - 10VDC	AS845-245	AS845-645			
	4 - 20mA	0 - 10VDC	AS845-246	AS845-646			
	4 - 20mA	4 - 20mA	AS845-247	AS845-647			
Input : Thermocouple J Type							
0 to 100°C	0 - 10VDC	0 - 10VDC	AS845-251	AS845-651	2840	UR	
	4 - 20mA	0 - 10VDC	AS845-252	AS845-652			
	4 - 20mA	4 - 20mA	AS845-253	AS845-653			
0 to 200°C	0 - 10VDC	0 - 10VDC	AS845-254	AS845-654			
	4 - 20mA	0 - 10VDC	AS845-255	AS845-655			
	4 - 20mA	4 - 20mA	AS845-256	AS845-656			
0 to 300°C	0 - 10VDC	0 - 10VDC	AS845-257	AS845-657			
	4 - 20mA	0 - 10VDC	AS845-258	AS845-658			
	4 - 20mA	4 - 20mA	AS845-259	AS845-659			
0 to 400°C	0 - 10VDC	0 - 10VDC	AS845-260	AS845-660			
	4 - 20mA	0 - 10VDC	AS845-261	AS845-661			
	4 - 20mA	4 - 20mA	AS845-262	AS845-662			
0 to 500°C	0 - 10VDC	0 - 10VDC	AS845-263	AS845-663			
	4 - 20mA	0 - 10VDC	AS845-264	AS845-664			
	4 - 20mA	4 - 20mA	AS845-265	AS845-665			
0 to 600°C	0 - 10VDC	0 - 10VDC	AS845-266	AS845-666			
	4 - 20mA	0 - 10VDC	AS845-267	AS845-667			
	4 - 20mA	4 - 20mA	AS845-268	AS845-668			
0 to 700°C	0 - 10VDC	0 - 10VDC	AS845-269	AS845-669			
	4 - 20mA	0 - 10VDC	AS845-270	AS845-670			
	4 - 20mA	4 - 20mA	AS845-271	AS845-671			
0 to 800°C	0 - 10VDC	0 - 10VDC	AS845-272	AS845-672			
	4 - 20mA	0 - 10VDC	AS845-273	AS845-673			
	4 - 20mA	4 - 20mA	AS845-274	AS845-674			



Dual Isolated Output

<http://www.shavison.com/pdf/63000.pdf>

Analog Signal Converters HSN : 85437099	Input	Output 1	Output 2	Order Code		MRP (₹ each)	Availability (UR : Upon Request)
				Aux Supply			
				90 ~ 270V AC	18 ~ 36V DC		
Input : RTD – PT100, 2 or 3 Wire							
 <p>Dual Isolated Output</p> <p>http://www.shavison.com/pdf/63000.pdf</p>	-100 to +100°C	0 - 10VDC	0 - 10VDC	AS845-301	AS845-701	2800	UR
		4 - 20mA	0 - 10VDC	AS845-302	AS845-702		
		4 - 20mA	4 - 20mA	AS845-303	AS845-703		
	-50 to +200°C	0 - 10VDC	0 - 10VDC	AS845-304	AS845-704		
		4 - 20mA	0 - 10VDC	AS845-305	AS845-705		
		4 - 20mA	4 - 20mA	AS845-306	AS845-706		
	-50 to +50°C	0 - 10VDC	0 - 10VDC	AS845-307	AS845-707		
		4 - 20mA	0 - 10VDC	AS845-308	AS845-708		
		4 - 20mA	4 - 20mA	AS845-309	AS845-709		
	0 to 100°C	0 - 10VDC	0 - 10VDC	AS845-310	AS845-710		
		4 - 20mA	0 - 10VDC	AS845-311	AS845-711		
		4 - 20mA	4 - 20mA	AS845-312	AS845-712		
	0 to 200°C	0 - 10VDC	0 - 10VDC	AS845-313	AS845-713		
		4 - 20mA	0 - 10VDC	AS845-314	AS845-714		
		4 - 20mA	4 - 20mA	AS845-315	AS845-715		
	0 to 300°C	0 - 10VDC	0 - 10VDC	AS845-316	AS845-716		
		4 - 20mA	0 - 10VDC	AS845-317	AS845-717		
		4 - 20mA	4 - 20mA	AS845-318	AS845-718		
	0 to 400°C	0 - 10VDC	0 - 10VDC	AS845-319	AS845-719		
		4 - 20mA	0 - 10VDC	AS845-320	AS845-720		
		4 - 20mA	4 - 20mA	AS845-321	AS845-721		
	0 to 500°C	0 - 10VDC	0 - 10VDC	AS845-322	AS845-722		
		4 - 20mA	0 - 10VDC	AS845-323	AS845-723		
		4 - 20mA	4 - 20mA	AS845-324	AS845-724		
	0 to 600°C	0 - 10VDC	0 - 10VDC	AS845-325	AS845-725		
		4 - 20mA	0 - 10VDC	AS845-326	AS845-726		
		4 - 20mA	4 - 20mA	AS845-327	AS845-727		
	0 to 700°C	0 - 10VDC	0 - 10VDC	AS845-328	AS845-728		
		4 - 20mA	0 - 10VDC	AS845-329	AS845-729		
		4 - 20mA	4 - 20mA	AS845-330	AS845-730		
	0 to 800°C	0 - 10VDC	0 - 10VDC	AS845-331	AS845-731		
		4 - 20mA	0 - 10VDC	AS845-332	AS845-732		
		4 - 20mA	4 - 20mA	AS845-333	AS845-733		

Analog Signal Converters HSN : 85437099	Input	Output	Order Code	MRP (₹ each)	Availability (UR : Upon Request)
 <p>Single Output</p> <p>Slim Size : 22.5mm</p> <p>Aux Supply : 24VDC</p> <p>http://www.shavison.com/pdf/62000.pdf</p>	0 - 20mV	0 - 10VDC	AS746-101	1720	UR
		4 - 20mA	AS746-102		
	0 - 75mV	0 - 10VDC	AS746-103		
		4 - 20mA	AS746-104		
	0 - 100mV	0 - 10VDC	AS746-122	1690	UR
	0 - 1VDC	0 - 10VDC	AS746-105		
	0 - 2VDC	4 - 20mA	AS746-106		
		0 - 10VDC	AS746-107		
	0 - 2.5VDC	4 - 20mA	AS746-108		
		0 - 10VDC	AS746-109		
	0 - 5VDC	4 - 20mA	AS746-110		
		0 - 10VDC	AS746-111		
	-3/0 to +10VDC	4 - 20mA	AS746-112		
		0 - 5VDC	AS746-121		
	0 - 10VDC	-3/0 to +10VDC	AS746-113		
		4 - 20mA	AS746-114		
	0 - 15VDC	2 - 10VDC	AS746-605	1720	UR
		0 - 5VDC	AS746-606		
	0 - 30VDC	0 - 10VDC	AS746-602		
		4 - 20mA	AS746-604		
0 - 50VDC	0 - 10VDC	AS746-607			
	4 - 20mA	AS746-115			
0 - 100VDC	4 - 20mA	AS746-116			
	0 - 10VDC	AS746-117			
0 - 200VDC	4 - 20mA	AS746-118			
	0 - 10VDC	AS746-119			
Contact factory for details	0-1K/ 2K / 2.5K/ 4K/ 5K/ 10K/ 20KHz	0 - 5/10VDC	SC1-F01-A-24VDC	1890	UR
		0/4 - 20mA	SC1-F01-B-24VDC		
Input : Frequency					

Analog Signal Converters HSN : 85437099	Input	Output	Order Code	MRP (₹ each)	Availability (UR : Upon Request)	
Input : Current (mA DC)						
0 - 20mA	0 - 10VDC	4 - 20mA	AS746-151	1690	UR	
	4 - 20mA	0 - 10VDC	AS746-152		UR	
4 - 20mA	0 - 10VDC	4 - 20mA	AS746-153		Ex Stock	
	4 - 20mA	0 - 5VDC	AS746-154		Ex Stock	
0 - 500mA	0 - 10VDC	0 - 5VDC	AS746-601	1720	UR	
	0 - 10VDC	0 - 10VDC	AS746-608			
Input : Thermocouple K Type						
0 to 300°C	0 - 10VDC	4 - 20mA	AS746-201	1870	UR	
	4 - 20mA	0 - 10VDC	AS746-202		UR	
0 to 400°C	0 - 10VDC	4 - 20mA	AS746-203		UR	
	4 - 20mA	0 - 10VDC	AS746-204		UR	
0 to 500°C	0 - 10VDC	4 - 20mA	AS746-205		UR	
	4 - 20mA	0 - 10VDC	AS746-206		UR	
0 to 600°C	0 - 10VDC	4 - 20mA	AS746-207		UR	
	4 - 20mA	0 - 10VDC	AS746-208		UR	
0 to 800°C	0 - 10VDC	4 - 20mA	AS746-209		UR	
	4 - 20mA	0 - 10VDC	AS746-210		UR	
0 to 1000°C	0 - 10VDC	4 - 20mA	AS746-211		UR	
	4 - 20mA	0 - 10VDC	AS746-212		UR	
0 to 1200°C	0 - 10VDC	4 - 20mA	AS746-213		UR	
	4 - 20mA	0 - 10VDC	AS746-214		UR	
-200 to +200°C	0 - 10VDC	4 - 20mA	AS746-215		UR	
	4 - 20mA	0 - 10VDC	AS746-216		UR	
-100 to +100°C	0 - 10VDC	4 - 20mA	AS746-217		UR	
	4 - 20mA	0 - 10VDC	AS746-218		UR	
0 to 100°C	0 - 10VDC	4 - 20mA	AS746-219		UR	
	4 - 20mA	0 - 10VDC	AS746-220		UR	
0 to 200°C	0 - 10VDC	4 - 20mA	AS746-221	UR		
	4 - 20mA	0 - 5VDC	AS746-222	UR		
0 to 200°C	0 - 5VDC	0 - 5VDC	AS746-603	1900	UR	
Input : Thermocouple J Type						
0 to 300°C	0 - 10VDC	4 - 20mA	AS746-226	1870	UR	
	4 - 20mA	0 - 10VDC	AS746-227		UR	
0 to 500°C	0 - 10VDC	4 - 20mA	AS746-228		UR	
	4 - 20mA	0 - 10VDC	AS746-229		UR	
0 to 700°C	0 - 10VDC	4 - 20mA	AS746-230		UR	
	4 - 20mA	0 - 10VDC	AS746-231		UR	
0 to 800°C	0 - 10VDC	4 - 20mA	AS746-232		UR	
	4 - 20mA	0 - 10VDC	AS746-233		UR	
Input : RTD – PT100, 2 or 3 Wire						
-100 to +100°C	0 - 10VDC	4 - 20mA	AS746-301		1820	UR
	4 - 20mA	0 - 10VDC	AS746-302	UR		
-50 to +50°C	0 - 10VDC	4 - 20mA	AS746-303	UR		
	4 - 20mA	0 - 10VDC	AS746-304	UR		
0 to 100°C	0 - 10VDC	4 - 20mA	AS746-305	UR		
	4 - 20mA	0 - 10VDC	AS746-306	UR		
0 to 200°C	0 - 10VDC	4 - 20mA	AS746-307	UR		
	4 - 20mA	0 - 10VDC	AS746-308	UR		
0 to 300°C	0 - 10VDC	4 - 20mA	AS746-309	UR		
	4 - 20mA	0 - 10VDC	AS746-310	UR		
0 to 400°C	0 - 10VDC	4 - 20mA	AS746-311	UR		
	4 - 20mA	0 - 10VDC	AS746-312	UR		
0 to 500°C	0 - 10VDC	4 - 20mA	AS746-313	UR		
	4 - 20mA	0 - 10VDC	AS746-314	UR		
0 to 600°C	0 - 10VDC	4 - 20mA	AS746-315	UR		
	4 - 20mA	0 - 10VDC	AS746-316	UR		
0 to 700°C	0 - 10VDC	4 - 20mA	AS746-317	UR		
	4 - 20mA	0 - 10VDC	AS746-318	UR		
0 to 800°C	0 - 10VDC	4 - 20mA	AS746-319	UR		
	4 - 20mA	0 - 10VDC	AS746-320	UR		
-50 to +200°C	0 - 10VDC	4 - 20mA	AS746-321	UR		
	4 - 20mA	0 - 10VDC	AS746-322	UR		







Single Output



Slim Size : 22.5mm

Aux Supply : 24VDC

<http://www.shavison.com/pdf/62000.pdf>

- Add suffix – ET to order code for products with extended temperature range.
- Price & availability upon request.



Digital Timer HSN : 91070000	Modes	Time Ranges	Output Contact	Supply Voltage	Size (mm)	Order Code	MRP (₹ each)
 Push Wheel http://www.shavison.com/pdf/E1000.pdf	<ul style="list-style-type: none"> On Delay Interval Counting : Down	9.99 Sec 99.9 Sec 999 Sec 99.9 Min 999 Min 99.9 Hr (Switch Selectable)	DPDT (2 C/O)	85~270V AC/DC	48x48	TDPW-48-Z	1860
					72x72	TDPW-72-Z	1690
					96x96	TDPW-96-Z	1820
				24V AC/DC	48x48	TDPW-48-24V	2240
					72x72	TDPW-72-24V	UR
					96x96	TDPW-96-24V	UR
 3 Digit, Single Display http://www.shavison.com/pdf/E2000.pdf	<ul style="list-style-type: none"> On Delay Interval Cyclic Counting : Up / Down	9.99 Sec 99.9 Sec 999 Sec 9.59 Min : Sec 99.9 Min 999 Min 9.59 Hr : Min 99.9 Hr 999 Hr (Programmable)	DPDT (2 C/O)	85~270V AC/DC	48x48	TD1D-48-Z	1620
					72x72	TD1D-72-Z	1890
					96x96	TD1D-96-Z	1930
				24V AC/DC	48x48	TD1D-48-24V	2120
					72x72	TD1D-72-24V	UR
					96x96	TD1D-96-24V	UR
 3 Digit, Dual Display http://www.shavison.com/pdf/E3000.pdf	<ul style="list-style-type: none"> On Delay Interval Cyclic Instantaneous +Delayed Counting : Up / Down	9.99 Sec 99.9 Sec 999 Sec 9.59 Min : Sec 99.9 Min 999 Min 9.59 Hr : Min 99.9 Hr 999 Hr (Programmable)	2 Nos. SPDT (1 C/O)	85~270V AC/DC	48x48	TD2D-48-Z	1810
					72x72	TD2D-72-Z	1730
					96x96	TD2D-96-Z	1750
				24V AC/DC	48x48	TD2D-48-24V	2450
					72x72	TD2D-72-24V	UR
					96x96	TD2D-96-24V	UR
 Multi Function http://www.shavison.com/pdf/E4000.pdf	<ul style="list-style-type: none"> On Delay Interval Cyclic Forward-pause-Reverse Batch Counting Instantaneous +Delayed Dual Set Point Counting : Up / Down	99.99 Sec 999.9 Sec 9999 Sec 99.59 Min : Sec 999.9 Min 9999 Min 99.59 Hr : Min 999.9 Hr 9999 Hr (Programmable)	2 Nos. SPDT (1 C/O)	85~270V AC/DC	72x72	TDMF-72-Z	2520

Protection Relays HSN : 85363000	Features	Output Contact	Order Code	MRP (₹ each)	Availability (UR : Upon Request)
 Phase Sequence Relay http://www.shavison.com/pdf/BE000.pdf	<ul style="list-style-type: none"> 3Ø / 3 wire input Monitors :- Phase sequence, Phase failure, Phase imbalance. LED Indication : Relay, Fault DIN Rail / Base Mounting 	SPDT (1 C/O)	PSR-415V	680	Ex Stock
 Voltage Protection Relay http://www.shavison.com/pdf/BF000.pdf	<ul style="list-style-type: none"> 3Ø / 3 wire input Monitors :- Phase Sequence, Phase Failure, L-L Under/ Over Voltage. LED Indication : Relay, Fault DIN Rail / Base Mounting 	SPDT (1 C/O)	VPR-415V	UR	UR

Analog Timer HSN : 91070000	Time Ranges	Output Contact	Supply Voltage	Order Code	MRP (₹ each)	Availability (UR: Upon Request)
 On Delay / Interval http://www.shavison.com/pdf/B1000.pdf	0 – 3 Sec / Min 0 – 10 Sec / Min 0 – 30 Sec / Min 0 – 60 Sec / Min (Switch Selectable)	SPDT (1 C/O)	230VAC Or 24V AC / DC	TADU-60M-W	590	Ex Stock
			110VAC Or 24V AC / DC	TADU-60M-X	600	Ex Stock
 On Delay / Interval http://www.shavison.com/pdf/B2000.pdf	0 – 3 Sec / Min 0 – 10 Sec / Min 0 – 30 Sec / Min 0 – 60 Sec / Min (Switch Selectable)	DPDT (2 C/O)	20 - 240VAC Or 12 - 240VDC	TADU-60M-U	830	Ex Stock
 On Delay / Interval http://www.shavison.com/pdf/B3000.pdf	0 – 1 Sec / Min / Hr 0 – 3 Sec / Min / Hr 0 – 10 Sec / Min / Hr 0 – 30 Sec / Min / Hr (Switch Selectable)	DPDT (2 C/O)	20 - 240VAC Or 12 - 240VDC	TADU-30H-U	960	Ex Stock
 On Delay http://www.shavison.com/pdf/B4000.pdf	0 – 30 Sec (Factory Set)	SPDT (1 C/O)	110VAC	TAON-30S-110AC	550	3 Weeks
			230VAC	TAON-30S-230AC	540	Ex Stock
	415VAC		TAON-30S-415AC	590	Ex Stock	
	0 – 60 Sec (Factory Set)		110VAC	TAON-60S-110AC	550	3 Weeks
			230VAC	TAON-60S-230AC	540	Ex Stock
			415VAC	TAON-60S-415AC	590	Ex Stock
 Star Delta http://www.shavison.com/pdf/B5000.pdf	Star Run up time range : 0-30 Sec, 0-60 Sec (Switch Selectable)	SPDT (1 C/O) each for Star & Delta	110VAC	TASD-60S-110AC	640	Ex Stock
	Change over time : 50 msec or 100 msec (Switch Selectable)		230VAC	TASD-60S-230AC	650	Ex Stock
			415VAC	TASD-60S-415AC	750	Ex Stock
 Cyclic ON First Or OFF First http://www.shavison.com/pdf/B6000.pdf	ON Time 0 – 1 Sec / Min / Hr 0 – 10 Sec / Min / Hr (Switch Selectable)	DPDT (2 C/O)	20 - 240VAC Or 12 - 240VDC	TACY-10H-U	1010	Ex Stock
	OFF Time 0 – 1 Sec / Min / Hr 0 – 10 Sec / Min / Hr (Switch Selectable)					
 True Power OFF http://www.shavison.com/pdf/B7000.pdf	0 – 60 Sec (Factory Set)	DPDT (2 C/O)	110 – 240V AC/DC	TATP-60S-Z	1930	Ex Stock
	0 – 180 Sec (Factory Set)			TATP-180S-Z	1910	Ex Stock

Analog Timer <small>HSN : 91070000</small>	Time Ranges	Output Contact	Supply Voltage	Order Code	MRP (₹ each)	Availability (UR: Upon Request)
 Forward-Pause-Reverse http://www.shavison.com/pdf/B8000.pdf	Run Time 1/2/4/8 Sec / Min (Switch Selectable) Pause Time 1/2/4/8/10/20/40/80 Sec / Min (Switch Selectable)	1 C/O (SPDT) each for Forward & Reverse	20 - 240VAC Or 12 - 240VDC	TAFR-8M-U	1150	Ex Stock
 On Delay / Interval http://www.shavison.com/pdf/BA000.pdf	0 – 3 Sec / Min 0 – 10 Sec / Min 0 – 30 Sec / Min 0 – 60 Sec / Min (Switch Selectable)	DPDT (2 C/O)	230VAC	T4DU-60M-230AC	750	Ex Stock
 On Delay / Interval http://www.shavison.com/pdf/B9000.pdf	0 – 3 Sec / Min 0 – 10 Sec / Min 0 – 30 Sec / Min 0 – 60 Sec / Min (Switch Selectable)	SPDT (1 C/O)	230VAC Or 24VAC/DC	T4DU-60M-W	650	Ex Stock
			110VAC Or 24VAC/DC	T4DU-60M-X	650	Ex Stock
 On Delay / Interval http://www.shavison.com/pdf/BB000.pdf	0 – 1 Sec / Min / Hr 0 – 3 Sec / Min / Hr 0 – 10 Sec / Min / Hr 0 – 30 Sec / Min / Hr (Switch Selectable)	DPDT (2 C/O)	230VAC	T4DU-30H-230AC	810	Ex Stock
 On Delay / Interval http://www.shavison.com/pdf/BC000.pdf	0 – 1 Sec / Min / Hr 0 – 3 Sec / Min / Hr 0 – 10 Sec / Min / Hr 0 – 30 Sec / Min / Hr (Switch Selectable)	DPDT (2 C/O)	20 - 240VAC Or 12 - 240VDC	T4DU-30H-U	950	Ex Stock
 Cyclic ON First Or OFF First http://www.shavison.com/pdf/BD000.pdf	ON Time 0 – 1 Sec / Min / Hr 0 – 10 Sec / Min / Hr (Switch Selectable) OFF Time 0 – 1 Sec / Min / Hr 0 – 10 Sec / Min / Hr (Switch Selectable)	DPDT (2 C/O)	20 - 240VAC Or 12 - 240VDC	T4CY-10H-U	1070	Ex Stock

Hooter HSN : 85311090	Features	Tone	Supply Voltage	Order Code	MRP (₹ each)	Availability (UR : Upon Request)
 72 x 72mm Standard http://www.shavison.com/pdf/C1000.pdf	<ul style="list-style-type: none"> • Volume control • Accept Function : Terminals on Back • Audio level 110db 	2	230VAC	H72S-230AC	600	Ex Stock
		2	24VDC	H72S-24DC	600	
		2	110VAC	H72S-110AC	610	
 96 x 96mm Standard http://www.shavison.com/pdf/C2000.pdf	<ul style="list-style-type: none"> • Volume control • Accept Function : Terminals on Back • Audio level 110db 	2	230VAC	H92S-230AC	660	Ex Stock
		2	24VDC	H92S-24DC	660	
		2	110VAC	H92S-110AC	680	
 96 x 96mm Flasher http://www.shavison.com/pdf/C2000.pdf	<ul style="list-style-type: none"> • LED Flasher • Volume control • Accept Function : Push Button on Front & Terminals on Back • Audio level 110db 	2	230VAC	H92F-230AC	780	Ex Stock
		2	24VDC	H92F-24DC	780	
 96 x 96mm Flasher Universal Supply http://www.shavison.com/pdf/C2200.pdf	<ul style="list-style-type: none"> • LED Flasher • Volume control • Accept Function : Push Button on Front & Terminals on Back • Audio level 110db • Universal Supply 	8	20 – 240VAC Or 12 - 240VDC	H98F-U	980	Ex Stock
 96 x 96mm General Purpose http://www.shavison.com/pdf/C2100.pdf	<ul style="list-style-type: none"> • Audio level 110db 	2	230VAC	H92G-230AC	580	Ex Stock

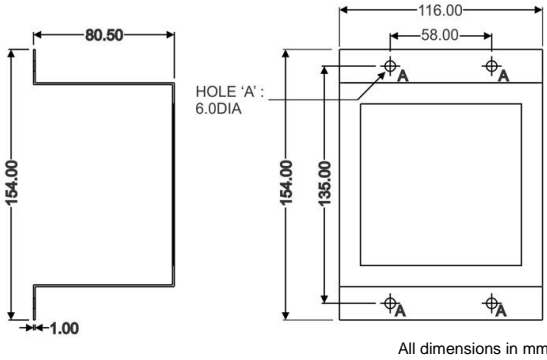
Hooter HSN : 85311090	Features	Tone	Supply Voltage	Order Code	MRP (₹ each)	Availability (UR Upon Request)
 <p>96 x 96mm Base Mount</p> <p>http://www.shavison.com/pdf/C2000.pdf</p> <p>http://www.shavison.com/pdf/C2200.pdf</p>	<ul style="list-style-type: none"> • LED Flasher • Volume control • Accept Function : Push Button on Front & Terminals on Back • Audio level 110db • Universal Supply • Base Mount 	2	230VAC	H92F-230AC-B	860	2 Weeks
		2	24VDC	H92F-24DC-B	860	
		2	24VDC	H92S-24DC-B	700	
		8	20 – 240VAC Or 12 - 240VDC	H98F-UB	1070	
 <p>Wall Mount Clamp For 96x96mm Hooter</p>	<ul style="list-style-type: none"> • Material : Black Powder Coated MS • For Wall Mounting 96x96mm Hooter 	 <p>All dimensions in mm</p>		FB468	170	UR

Modbus I/O Modules HSN : 85437099	Description	Model	I/O	Order Code	MRP (₹ each)	Availability (UR : Upon Request)
 <p>SMART I/O's</p> <p>http://www.shavison.com/pdf/70000.pdf</p> <p>Application Note</p>	<ul style="list-style-type: none"> • Supports MODBUS RTU Comm. Protocol • On board SMPS works from 90 to 270VAC 	Relay Output Module	Output : 8 Channel, 1 C/O Relays	AS455-101	3050	3 Weeks
		Relay Output Module with Socket Mounted	Output : 8 Channel, 1 C/O Relays	AS455-101-S	3160	3 Weeks
		Digital Input Module	Input : 8 DI	AS456-101	2510	3 Weeks
		Combo Module	Input : 4 DI Output : 4 channel, 1 C/O Relays	AS457-101	2810	3 Weeks



TERMS :

- This Price List supersedes earlier price lists.
- MRP indicated, is inclusive of packing, GST, ex works Ambernath.
- Delivery : Through Courier/Transport. Freight shall be charged extra at actual or freight to pay basis.
- Delivery Period : Delivery period mentioned is indicative. Ex-stock items are subject to prior sale. Please confirm availability before placing purchase order.
- Goods once sold, shall not be taken back or replaced.
- Our responsibility ceases as soon as goods leaves our premises. Insurance shall be buyer's responsibility.
- Prices & terms are subject to change without prior notice.
- Payment Terms: 100% against proforma invoice by either cash or DD payable at Mumbai or through net banking / RTGS / NEFT. Cheques should be payable at Mumbai & goods shall be dispatched after the cheque clearance.
- Subject to Kalyan jurisdiction only.

WARRANTY :

Shavison Electronics Pvt. Ltd. warrants the products manufactured by us, to be free from defects in material & workmanship for 12 months from the date of invoice. The services during the warranty period will be rendered on return of the product to our Ambernath works with freight paid to & fro.

The obligation under this warranty is limited to only repairing or replacing the product at our own discretion. This warrantee shall not apply to any defect, failure or damage caused by expiry of life cycle, accident, negligence, mis-application, alteration or attempt to repair, service or modify in any way. This warrantee does not cover any consequential or incidental damages occurred due to failure or malfunction of the product.

Our Bankers :

Union Bank of India
Dombivli (East) Branch
A/C No. : 576204010000027
NEFT / RTGS Code : UBIN0557625

GST & PAN details :

- GSTIN : 27AAPCS5652N1ZI
- PAN : AAPCS5652N
- CIN : U31401MH2011PTC215241

























Contact Persons :

- **Sales** : Mrs. Bhat - Cell No. +91 8237 44 2320
Ms. Jagruti - Cell No. +91 9594 16 8704
Email : shavison@shavison.com
- **Technical** : Mr. Amar Asawale / Mr. Umesh Madhavi
Boardlines : +91-251-2620417, 2620427
+91-9820362980, 72648 90900
 +91-72640 00464
Email : shavison@shavison.com

Notes :



AMBERNATH WORKS

									
SMPS					SMPS Accessories		Signal Converters / Isolators		
									
Timers	Hooters	DC UPS	Battery Chargers	FRC / D-SUB(M/F) Terminator Modules		FRC / D-SUB(M/F) Cables			
									
Relay Interface Modules		SSR Modules		OPTO Interface Modules	Diode / Resistor Modules		Special Products		

Peripherals for Industrial Automation *Since 1997*

Every care is taken for correctness of the details. Please ensure suitability of products for your specific application/use before ordering. Due to continuous development, the details are subject to change without prior notice. Visit our website www.shavison.com for latest information of products. We welcome development of products to suit your specific requirements.

Represented By:



SHAVISON ELECTRONICS PVT. LTD.

Unit No:G-5/6, B Wing, Plot K-3, Udyog Bhavan No:2, Anand Nagar MIDC, Ambernath(E) 421 506, MH, INDIA.

Email: shavison@shavison.com

Website: www.shavison.com

Boardlines : +91-251-2620417, 2620427

+91-98203 62980, 72648 90900

+91-72640 00464

Peripherals for Industrial Automation **SHAVISON**®